

KENWOOD

AUDIO VIDEO SURROUND RECEIVER

VRS-6100

INSTRUCTION MANUAL

KENWOOD CORPORATION

Quick Start Reference

Please read the following pages so that you can enjoy the surround sound at the best condition.

(These pages give shortcut explanations on how to connect the speaker system to the receiver, set up the speakers and play a source.)

"Let's play DVD video software" - 16 - 17

About the supplied remote control

Compared to standard remote controls, the remote control supplied with this receiver has several operation modes. These modes enable the remote control to control other audio/video components. In order to effectively use the remote control, it is important to read the operating instructions and obtain a proper understanding of the remote control and how to switch its operation modes (etc.).

Using the remote control without completely understanding its design and how to switch the operation modes may result in incorrect operations.

For the U.S.A.

Register Online

**Register your Kenwood Home Audio product
at www.kenwoodusa.com**

**Plus opt in to receive e-mail updates and other offers when you
register at our web site.**



Before applying power

 **Caution** : Read this page carefully to ensure safe operation.

Units are designed for operation as follows.

U.S.A. and Canada AC 120 V only

Safety precautions

WARNING : TO PREVENT FIRE OR ELECTRIC SHOCK, DO NOT EXPOSE THIS APPLIANCE TO RAIN OR MOISTURE.



CAUTION
RISK OF ELECTRIC SHOCK
DO NOT OPEN



CAUTION: TO REDUCE THE RISK OF ELECTRIC SHOCK, DO NOT REMOVE COVER (OR BACK). NO USER-SERVICEABLE PARTS INSIDE. REFER SERVICING TO QUALIFIED SERVICE PERSONNEL.



THE LIGHTNING FLASH WITH ARROWHEAD SYMBOL, WITHIN AN EQUILATERAL TRIANGLE, IS INTENDED TO ALERT THE USER TO THE PRESENCE OF UNINSULATED "DANGEROUS VOLTAGE" WITHIN THE PRODUCT'S ENCLOSURE THAT MAY BE OF SUFFICIENT MAGNITUDE TO CONSTITUTE A RISK OF ELECTRIC SHOCK TO PERSONS.



THE EXCLAMATION POINT WITHIN AN EQUILATERAL TRIANGLE IS INTENDED TO ALERT THE USER TO THE PRESENCE OF IMPORTANT OPERATING AND MAINTENANCE (SERVICING) INSTRUCTIONS IN THE LITERATURE ACCOMPANYING THE APPLIANCE.

How to use this manual

This manual is divided into four sections, Preparations, Operations, Remote Control, and Additional Information.

Preparations

Shows you how to connect your audio and video components to the receiver and prepare the surround processor. Since this receiver works with all your audio and video components, we will guide you in setting up your system to be as easy as possible.

Operations

Shows you how to operate the various functions available on the receiver.

Remote Control

Shows you how to operate other components using the remote control, as well as a detailed explanation of all remote control operations. Once you have setup the remote control, you'll be able to operate both this model and your KENWOOD DVD player using the remote control supplied with this model.

Additional Information

Shows you additional information such as "In case of difficulty" (trouble shooting) and "Specifications".

Maintenance of the unit

When the front panel or case becomes dirty, wipe with a soft, dry cloth. Do not use thinner, benzine, alcohol, etc. for these agents may cause discoloration.

In regard to contact cleaner

Do not use contact cleaners because it could cause a malfunction. Be specially careful not to use contact cleaners containing oil, for they may deform the plastic component.

Unpacking

Unpack the unit carefully and make sure that all the accessories are present.

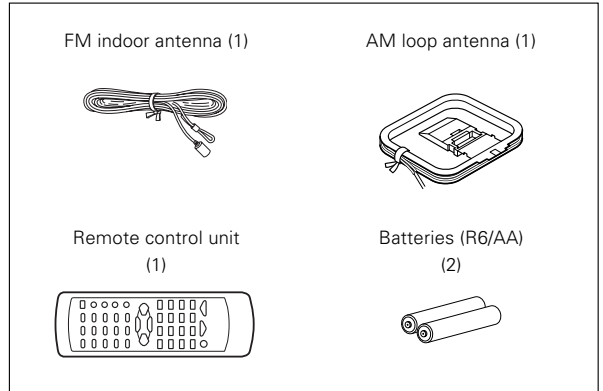

If any accessories are missing, or if the unit is damaged or fails to operate, notify your dealer immediately. If the unit was shipped to you directly, notify your shipper immediately. Kenwood recommends that you retain the original carton and packing materials in case you need to move or ship the unit in the future. **Keep this manual handy for future reference.**

Special features

True home theater sound → 28 ~ → 29

This receiver incorporates a wide variety of surround modes to bring you maximum enjoyment from your video software. Select a surround mode according to your equipment or the software you are going to play and enjoy!

- Dolby Digital EX
- Dolby PRO LOGIC IIx, Dolby PRO LOGIC II
- Dolby Digital
- DTS-ES
- DTS NEO:6
- DTS
- DSP Mode

ACTIVE EQ → 23



ACTIVE EQ mode will produce a more dynamic sound quality in any condition. You can enjoy a more impressive sound effect when ACTIVE EQ is turned on during Dolby Digital and DTS playback.

Remote control → 34

In addition to the basic receiver, the remote control supplied with this receiver can also operate KENWOOD DVD player. Just follow the simple setup procedure.

Contents

Caution : Read the pages marked  carefully to ensure safe operation.

	Before applying power	2
	Safety precautions	2
	How to use this manual	3
	Unpacking	3
	Special features	4
	Contents	5
	Names and functions of parts	6
	Main unit	6
	Remote control unit	7

Remote Control	Basic remote control operations for other components	34
	DVD player operation keys	34

Additional Information	In case of difficulty	35
	Specifications	37

Preparations	Setting up the system	8
	Connecting a DVD player	9
	Connecting video components, audio components	10
	Digital connections	11
	Connecting the speakers	12
	Connecting the speaker terminals ...	13
	PRE OUT connections	14
	Connecting to the FRONT AUX jacks ...	14
	Connecting the antennas	15
	Preparing the remote control	15
	Let's play DVD video software	16
	Preparing for playback	18
	Speaker settings	18

Operations	Normal playback	22
	Listening to a source component ...	22
	Adjusting the sound	23
	Recording	25
	Analog sources	25
	Digital sources	25
	Listening to radio broadcasts	26
	Tuning radio stations	26
	Presetting radio stations	26
	Receiving preset stations	27
Receiving preset stations in order (P.CALL)	27	
	Ambience effects	28
	Surround modes	28
	Surround play	30
	Convenient functions	32

Names and functions of parts

Main unit

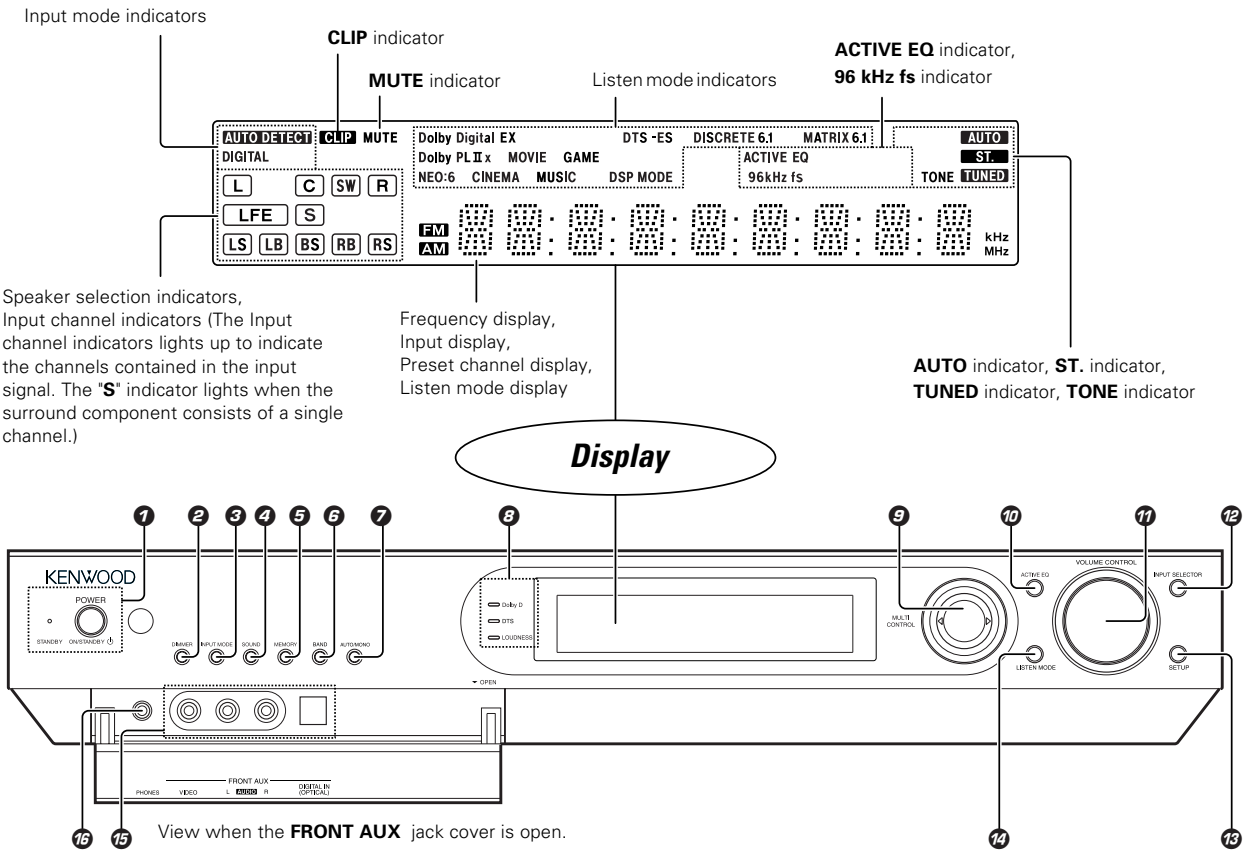

1 POWER ON/STANDBY \updownarrow key - 18

Use to turn the power ON/STANDBY.

STANDBY indicator

Lights when the power is in the standby mode.

2 DIMMER key - 25

Use to select the REC MODE.

Use to adjust the brightness of the display.

3 INPUT MODE key - 8

Use to switch between the full auto, digital and analog input.

4 SOUND key - 29

Use to adjust the sound quality and the ambience effects.

5 MEMORY key - 26

Use to presetting of radio stations.

6 BAND key - 26

Use to select the broadcast band.

7 AUTO/MONO key - 26

Use to select the auto or manual tuning mode.

8 Dolby D indicator - 30

Lights when the receiver is in the Dolby Digital mode.

DTS indicator - 30

Lights when the receiver is in the DTS mode.

LOUDNESS indicator - 23

Lights when the LOUDNESS mode is ON.

9 MULTI CONTROL button - 17

Use to control a variety of settings.

10 ACTIVE EQ key - 23

Use to select ACTIVE EQ's setting.

11 VOLUME CONTROL knob - 22

Use to adjust the receiver volume.

12 INPUT SELECTOR key - 22

Use to select input sources.

13 SETUP key - 17

Use to select the speakers' settings etc.

14 LISTEN MODE key - 30

Use to select the listening mode.

15 FRONT AUX jacks - 14

16 PHONES jack - 24

Use for headphone listening.

Standby mode

While the standby indicator is lit, a small amount of power is supplied to the system to back up the memory. This is called standby mode. Under the condition, the system can be turned ON by the remote control unit.

Remote control unit

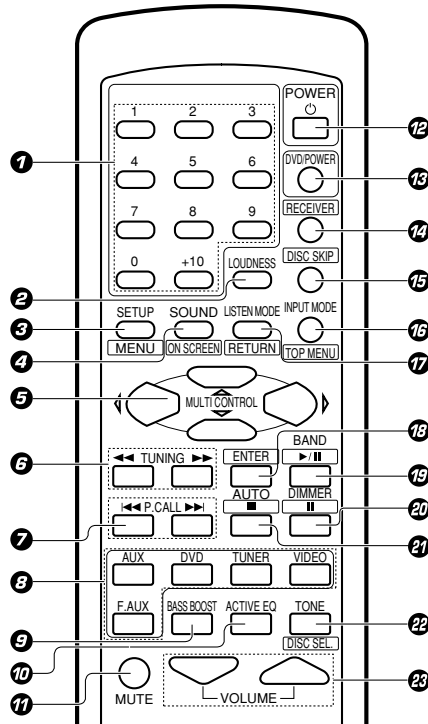

If the name of a function is different on the receiver and on the remote control, the name of the remote control key in this manual is indicated in parentheses.

- 1 Numeric keys** → 27 → 34
If CD or MD is selected as the input source, these keys function as numeric keys. If tuner is selected as the input source, these keys are used to call up station presents.
- 2 LOUDNESS key** → 23
Use to switch the status of LOUDNESS.
- 3 SETUP key** → 18
Use to select the speakers' settings etc.
MENU key → 34
Use to operate the DVD component.
- 4 SOUND key** → 28
Use to adjust the sound quality and the ambi-ence effects.
ON SCREEN key → 34
Use to operate the DVD component.
- 5 MULTI CONTROL (Δ/▽) keys** → 18
Use to control a variety of settings as well as in tuning of radio broadcasting.
Use to operate other components.
- 6 TUNING keys** → 26
Use to tuning of radio broadcasting.
◀◀/▶▶ keys
If CD, MD or TAPE is selected as the input source, these keys function as search key.
- 7 P.CALL keys** → 27
If tuner is selected as the input source, these keys function as preset channel call keys.
◀◀/▶▶ keys
If CD or MD is selected as the input source, these keys function as skip keys.

- 8 Input Selector keys (TUNER, DVD, VIDEO, AUX, F. AUX)** → 22
Use to select input sources.
- 9 BASS BOOST key** → 23
Use to select the maximum adjustment setting for the low frequency range.
- 10 ACTIVE EQ key** → 23
Use to select ACTIVE EQ setting.
- 11 MUTE key** → 24
Use to temporarily mute the sound.
- 12 POWER ⏻ key** → 18
Use to turn the receiver ON/STANDBY.
- 13 DVD/POWER key** → 34
Use to operate the DVD component.
- 14 RECEIVER key** → 18 → 32
Use to return to the operation of this model.
- 15 DISC SKIP key**
If CD is selected as the input source, this key functions as the multi-CD player disc skip key.
- 16 INPUT MODE key** → 8
Use to switch between the full auto, digital and analog input.
TOP MENU key → 34
Use to operate the DVD component.
- 17 LISTEN MODE key** → 30
Use to select the listening mode.
RETURN key → 34
Use to operate the DVD component.
- 18 ENTER key**
Use to operate other components.

- 19 BAND key** → 26
Use to select the broadcast band.
▶/|| key
If CD is selected as the input source, this keys function as the play/pause key.
If MD or TAPE is selected as the input source, this key functions as the play key.
- 20 DIMMER key** → 25 → 33
Use to select the REC MODE.
Use to adjust the brightness of the display.
- || key**
Use to operate other components.
- 21 AUTO key** → 26
Use to select the auto or manual tuning mode.
■ key
If CD, MD or TAPE is selected as the input source, this key functions as the stop key.
- 22 TONE key** → 23
Use to switch the status of TONE control.
DISC SEL. key → 34
Use to operate the DVD component.
- 23 VOLUME keys** → 22
Use to adjust the receiver volume.

Setting up the system

CAUTION

Make sure that the power cord plug is disconnected from the AC wall outlet before proceeding to connections. Also be sure to disconnect the power cord plug from the AC wall outlet before changing connections. For the connections of other system components, see pages 9 to 15.

When connecting an associated system component, be sure to read its instruction manual.

Microcomputer malfunction

If operation is not possible or an erroneous display appears, even though all connections have been made properly, reset the micro computer referring to "In case of difficulty". → [35]

Notes

1. Be sure to turn off the system components before connecting them.
2. Be sure to insert every connection cable completely into the jack. Incomplete connection may result in absence of audio output or production of noise.
3. Be sure to disconnect the power cord from the AC wall outlet before inserting or removing a connection cable.
4. Installation of outdoor antenna is a dangerous work. Please have your dealer or a specialized technician install it.
5. Select the speaker installation locations with care. If a speaker is installed near a source of magnetism including a magnet, the mutual interference with the speaker may produce color irregularities on the TV screen.

Analog audio connections

Audio connections are made using RCA pin cords. These cables transfer stereo audio signal in an "analog" form. This means the audio signal corresponds to the actual audio of two channels. These cables usually have 2 plugs on each end, one red for the right channel and one white for the left channel.

These cables are to be prepared separately by the user.

CAUTION

Be sure to adhere to the following, or proper ventilation will be blocked causing damage or fire hazard.

- Do not place any objects impairing heat radiation onto the top of the unit.
- Leave some space around the unit (from the largest outside dimension including projection) equal to or greater than, shown below.

Top panel : 10 cm

Side panel : 10 cm

Back panel : 10 cm

- Do not use the appliance on a bed, sofa, rug or similar surface. Otherwise, absorption of dust may cause a fire hazard.

Input mode settings

DVD, VIDEO and **FRONT AUX** inputs each include jacks for digital audio input and analog audio input.

The initial factory settings for audio signal playback for DVD, VIDEO and FRONT AUX are full auto.

After completing connections and turning on the receiver, follow the steps below.

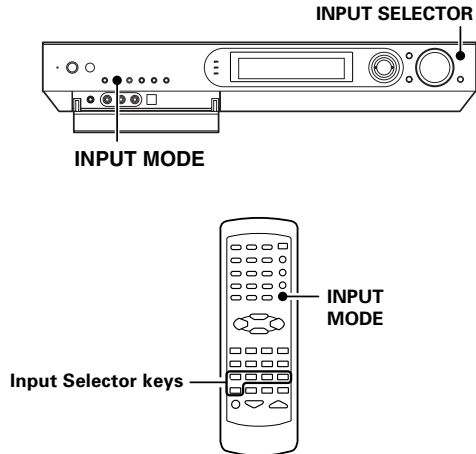

❶ Use the **INPUT SELECTOR** key (or Input Selector keys) to select **DVD, VIDEO** or **FRONT AUX**.

❷ Press the **INPUT MODE** key.

Each press switches the setting as follows:

- ➔ ❶ **"F-AUTO"**: Auto detect
("AUTO DETECT" indicator lights up)
 - ➔ ❷ **"D-MANUAL"**: Fixed to digital input
("DIGITAL" indicator lights up)
 - ➔ ❸ **"ANALOG"**: Fixed to analog input *
("AUTO DETECT", "DIGITAL" indicator goes off)
- * Can not be selected for DTS playback.

Auto detect:

In **"F-AUTO (FULL AUTO)"** mode ("AUTO DETECT" indicator light up), the receiver detects the digital or analog input signals automatically. The receiver will select the input mode and listening mode automatically during playback to match the type of input signal (Dolby Digital, PCM, DTS) and the speaker setting. → [30]
The **"DIGITAL"** indicator lights up when a digital signal is detected. The **"DIGITAL"** indicator is extinguished when no digital signal is detected.

Fixed to digital input:

Select this mode if you want to keep the decoding condition (Dolby Digital, DTS, PCM, etc.) in the current listen mode.

When **"D-MANUAL (DIGITAL MANUAL)"** mode is selected, the set listen modes may be changed automatically depending on the listen mode. → [30]

Fixed to analog input:

Select this setting to play analog signals from a VCR, etc.

If the **INPUT MODE** key is pressed quickly, sound may not be produced. Press the **INPUT MODE** key again.

Connecting a DVD player

If you have connected a DVD player to the receiver with digital connection, be sure to read the **"Input mode settings"** section carefully. 

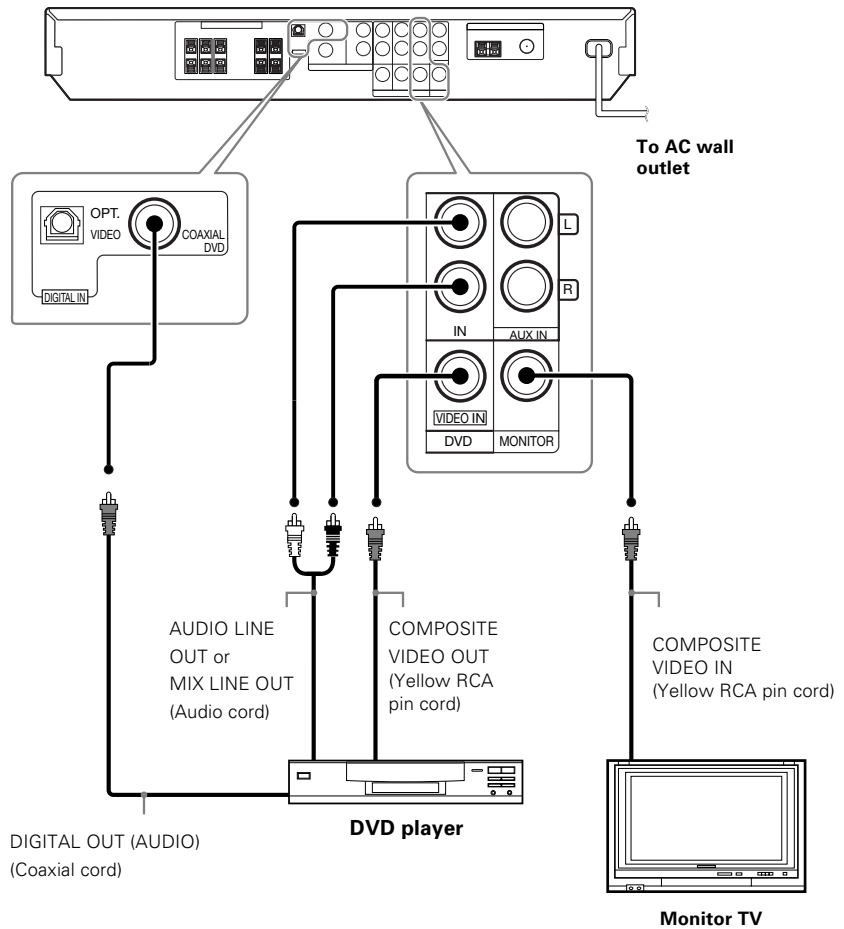

- Digital audio connections are required when playing multi-channel signals such as the Dolby Digital and DTS signals.
- To play the DVD player connected in this page, select the "DVD" input selector. 

Connecting video components, audio components

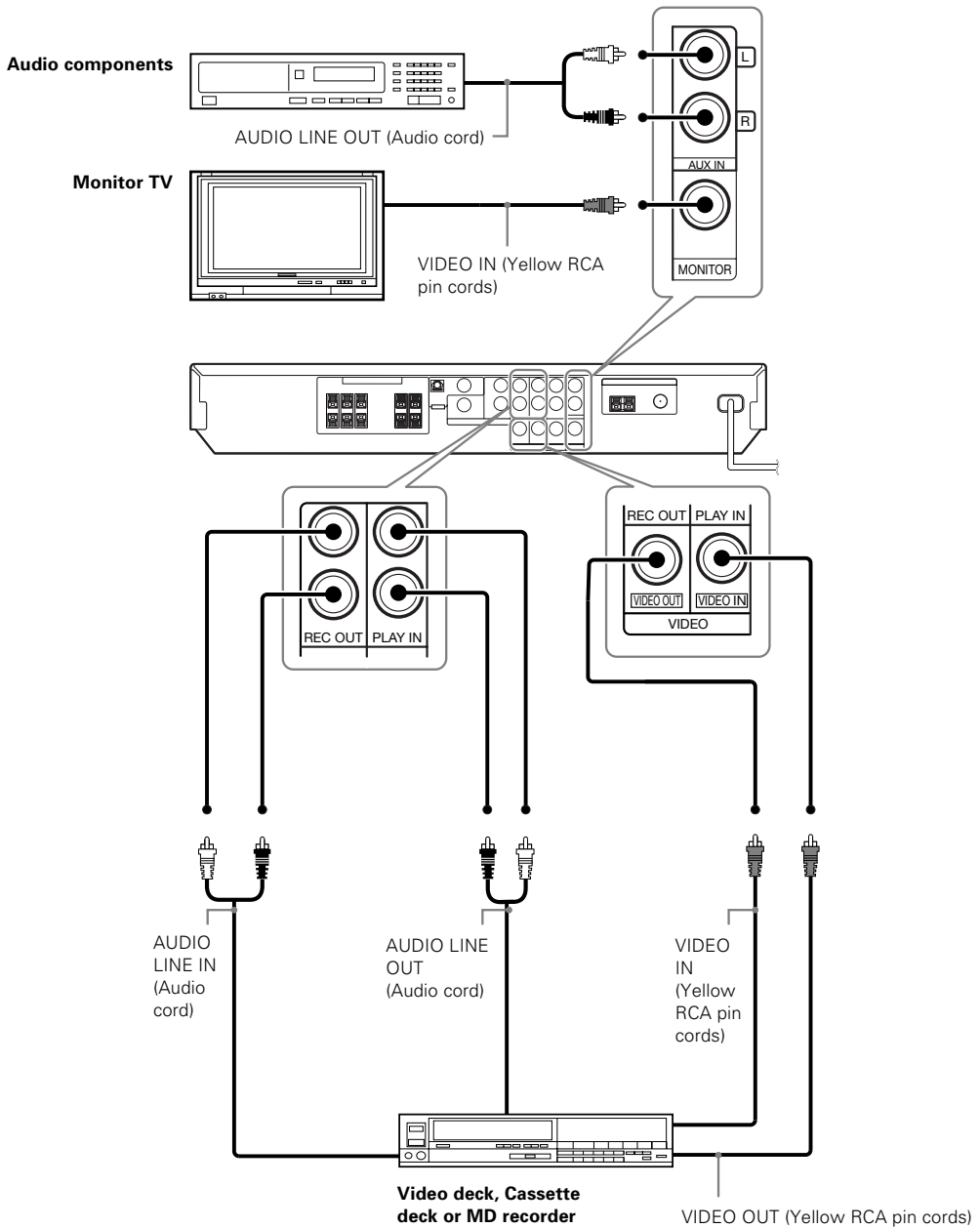

Digital connections

The digital in jacks can accept DTS, Dolby Digital, or PCM signals. Connect components capable of outputting DTS, Dolby Digital, or standard PCM (CD) format digital signals.

If you have connected a DVD player to the receiver with digital connection, be sure to read the "Input mode settings" section carefully. 

DTS disclaimer clause

When playing DTS-encoded discs, excessive noise will be exhibited from the analog stereo outputs of the CD or DVD player. To enjoy DTS Digital Surround™ playback, this unit must be connected to the digital output of the CD or DVD player.

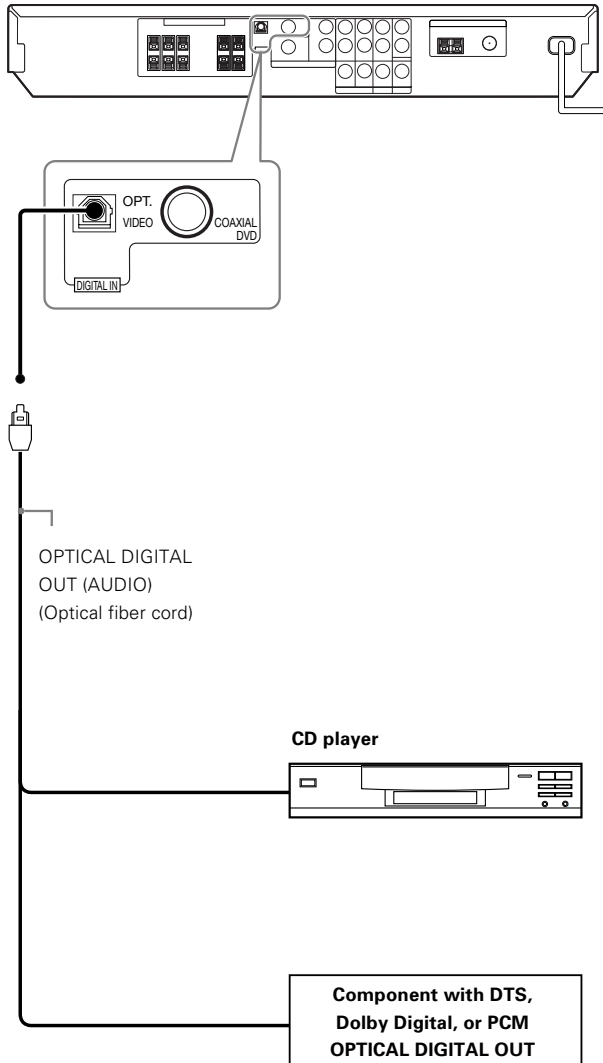

Connect the video signal and analog audio signals to the **VIDEO** jacks.
(See "Connecting video components, audio components". )

Connecting the speakers

CAUTION

Make sure that the power cord plug is disconnected from the AC wall outlet before proceeding to speaker cord connections. If the conductor wires on the extremity of speaker cord are untwisted, there is a risk of short-circuiting. Be sure to twist them well before connecting the speaker cord.

Whether each speaker is connected properly can be confirmed by outputting the test tone and checking if each speaker channel outputs audio. For details, see "Speaker settings" (Step 5 Adjust the speaker volume level). → 20

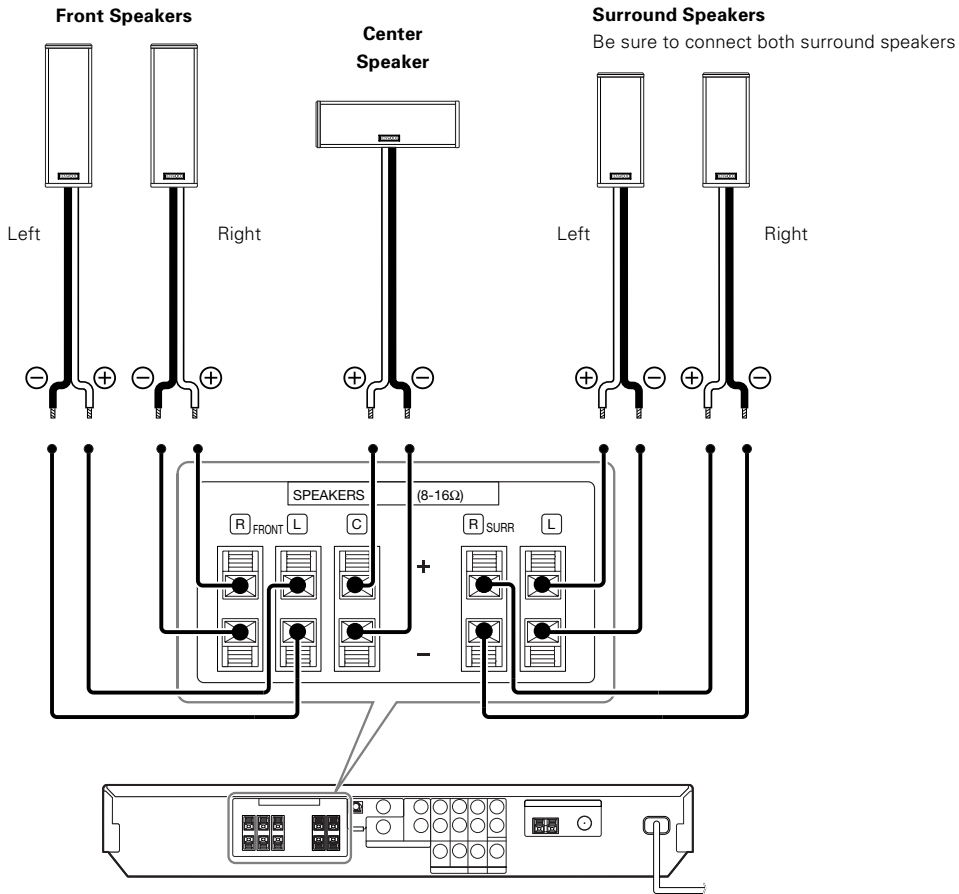

Connecting the speaker terminals

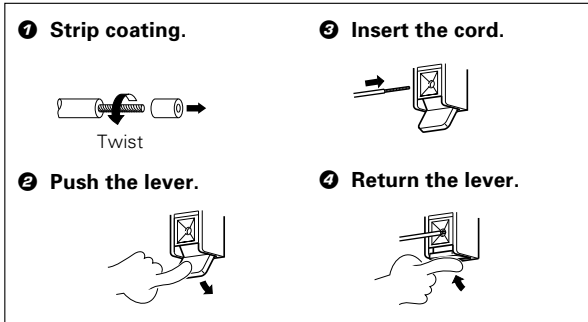

- Never short circuit the + and – speaker cords.
- If the left and right speakers are connected inversely or the speaker cords are connected with reversed polarity, the sound will be unnatural with ambiguous acoustic imaging. Be sure to connect the speakers correctly.

Speaker impedance

After confirming the speaker impedance indications printed on the rear panel of the receiver, connect speakers with matching impedance ratings. Using speakers with a rated impedance other than that indicated on the rear panel of the receiver could result in malfunctions or damage to the speakers or receiver.

Speaker placement

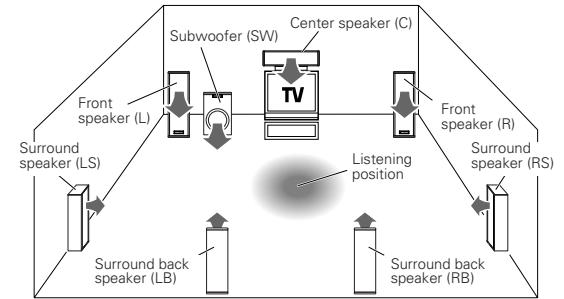

Front speakers: Place the left and right speakers at each side of your TV. Angle the speakers towards the listening area to enhance the stereo effect.

Center speaker: Place front and center. This speaker stabilizes the sound image and helps recreate sound motion. Required for surround playback.

Surround speakers: Place the surround speakers as high as possible, either directly to the sides of the listening area or else slightly behind the listening area. Adjust the angles so that these speakers are facing directly towards the listeners.

Subwoofer: Usually, place the subwoofer in the front center position in the listening room, near one of the front speakers near the center speaker. (Since the subwoofer has less directivity than other speakers, it can be placed almost in any position that can offer the best low frequency reproduction according to the room layout.)

Surround back speakers: Place the surround back speaker behind the listening position, at the same height as the left and right surround speakers.

- Although the ideal surround system consists of all the speakers listed above, if you don't have a center speaker or a subwoofer, you can divide those signals between the available speakers in the speaker settings steps to obtain the best possible surround reproduction from the speakers you have available. — 18

PRE OUT connections

The receiver has additional **PRE OUT** jacks. Note that the output from the **PRE OUT** jacks needs to be connected to an external power amplifier. If you want to connect surround back speakers to these jacks, be always sure to connect two surround back speakers for the left and right.

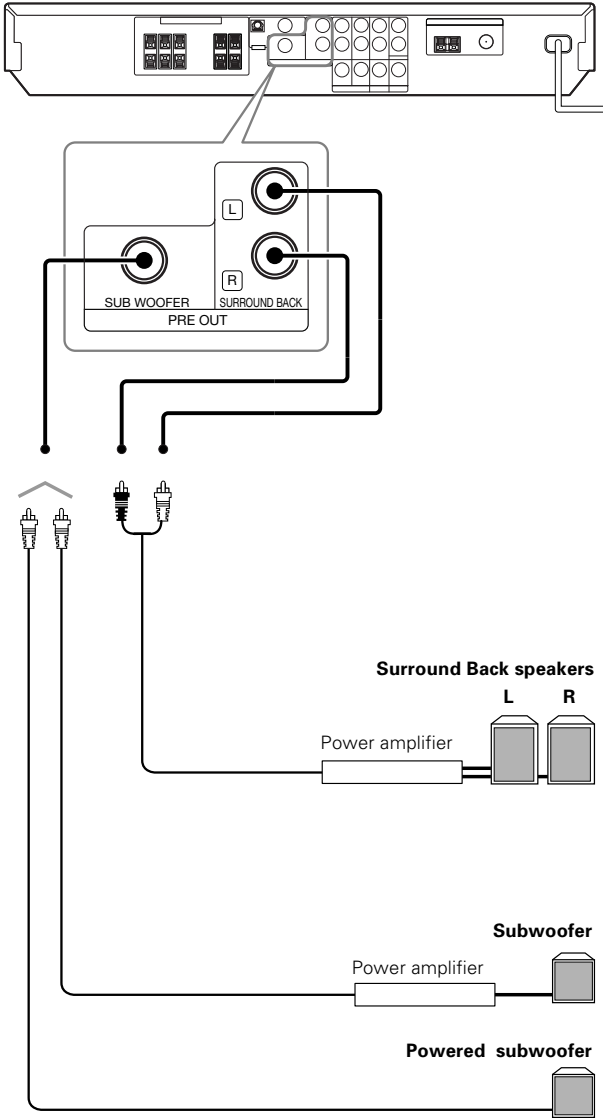

Connecting to the FRONT AUX jacks

If you use a component that you do not usually connect to the receiver, such as a portable video camera, connect it to the **FRONT AUX** jacks on the front panel of the receiver. These jacks are particularly convenient when dubbing audio/video from a portable video camera.

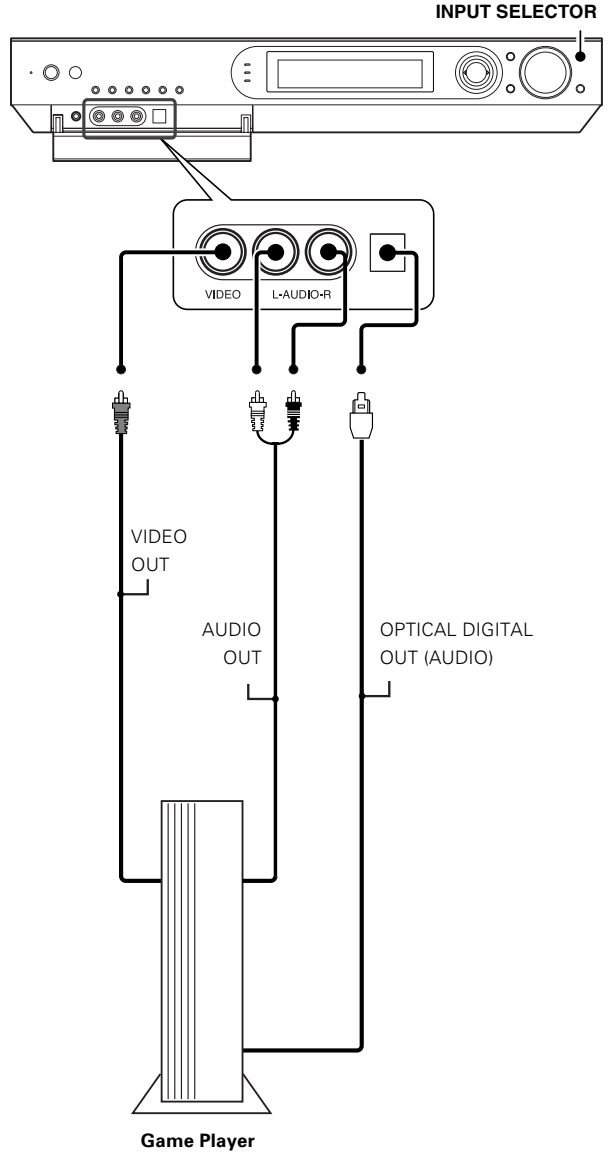

● Connecting a speaker cord directly to a PRE OUT jack will not produce any sound from the speaker.

Connecting the antennas

AM loop antenna

The supplied loop antenna is for use indoors. Place it as far as possible from the receiver, TV set, speaker cords and power cord, and adjust the direction for best reception.

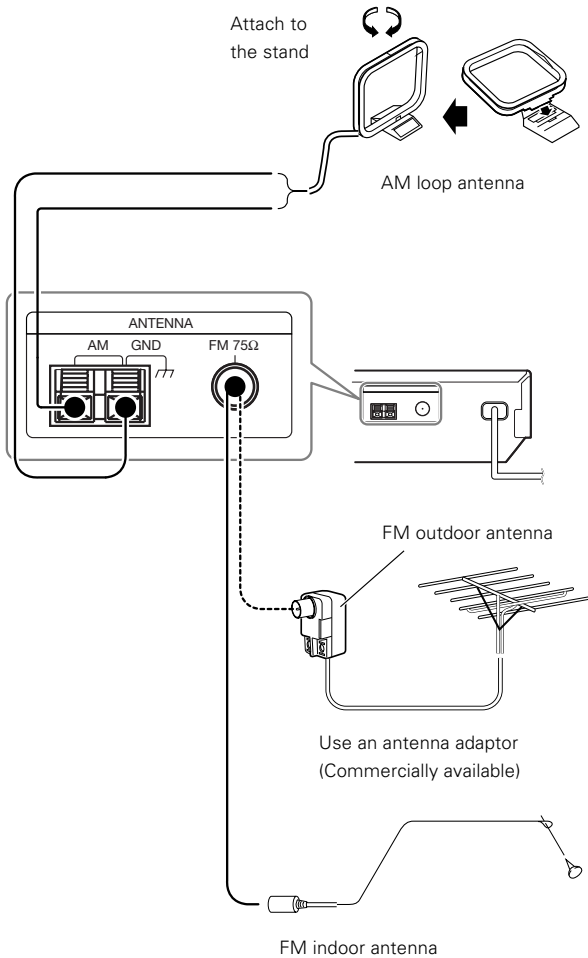
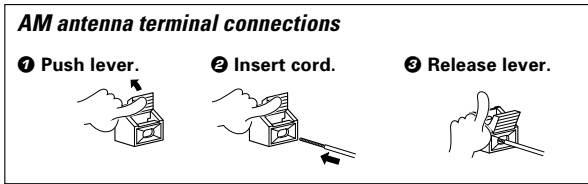

FM indoor antenna

The supplied indoor antenna is for temporary use only. For stable signal reception we recommend using an outdoor antenna. Disconnect the indoor antenna when you connect one outdoors.

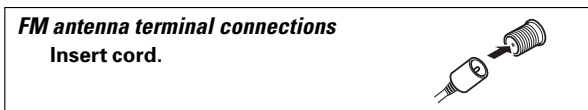

FM outdoor antenna

Lead the 75Ω coaxial cable connected to the FM outdoor antenna into the room and connect it to the **FM 75Ω** terminal.

Preparing the remote control

Loading the batteries

1 Remove the cover.

2 Insert the batteries.

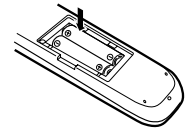
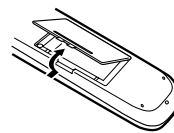

3 Close the cover.

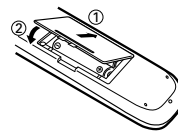

- Insert two AA-size (R6) batteries as indicated by the polarity markings.

Remote control operation

When the **STANDBY** indicator is lit, the power turns ON when you press the **POWER** on the remote control. When the power comes ON, press the key you want to operate.

Operating other component range

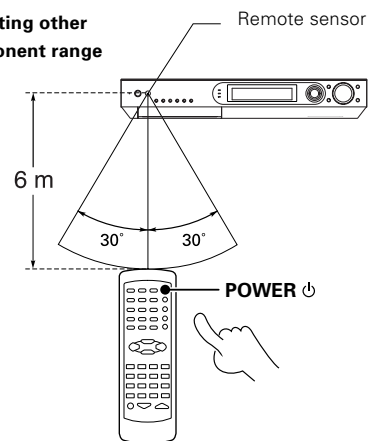

- When pressing more than one remote control key successively, press the keys securely by leaving an interval of 1 second or more between keys.

Notes

1. The supplied batteries may have shorter lives than ordinary batteries due to use during operation checks.
2. When the remote-controllable distance gets shorter than before, replace both batteries with new ones.
3. Placing the remote sensor in direct sunlight, or in direct light from a high frequency fluorescent lamp may cause a malfunction. In such a case, change the location of the system installation to prevent malfunction.

STEP 1 Connect the speakers and TV to the receiver.

For details, see "Setting up the system" - 8 ~ - 14

CAUTION

Make sure that the power cord plug is disconnected from the AC wall outlet before proceeding to speaker cord connections. If the conductor wires on the extremity of speaker cord are untwisted, there is a risk of short-circuiting. Be sure to twist them well before connecting the speaker cord.

Connection of speakers:

(A)	Front speakers (L,R)
(B)	Center speaker
(C)	Subwoofer
(D)	Surround speakers (L,R)
(E)	Surround back speakers (L,R)

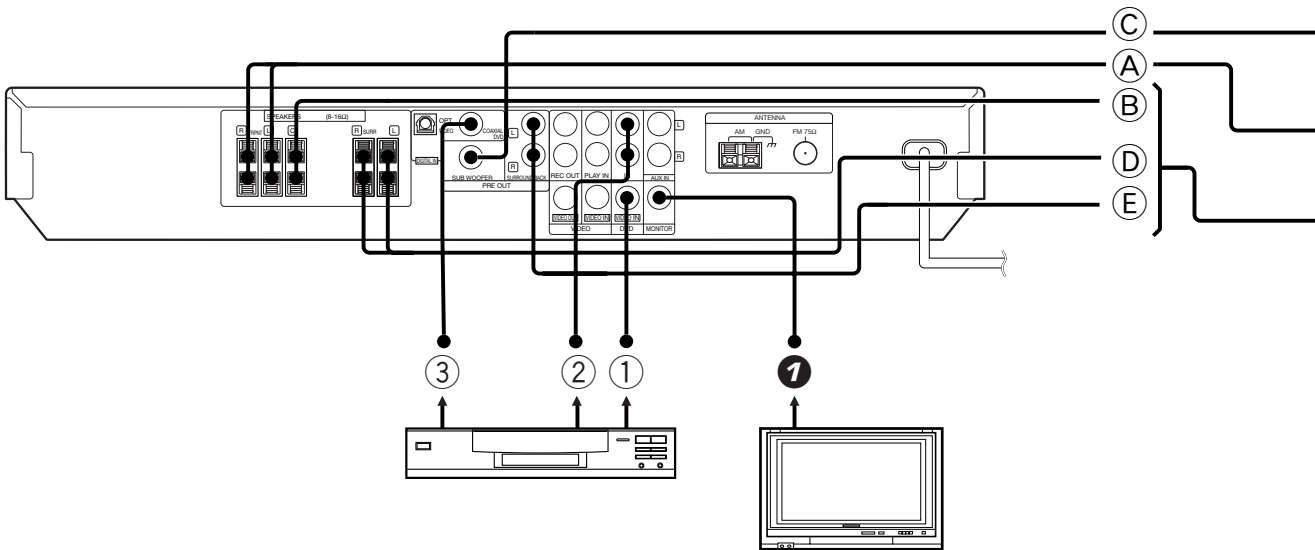
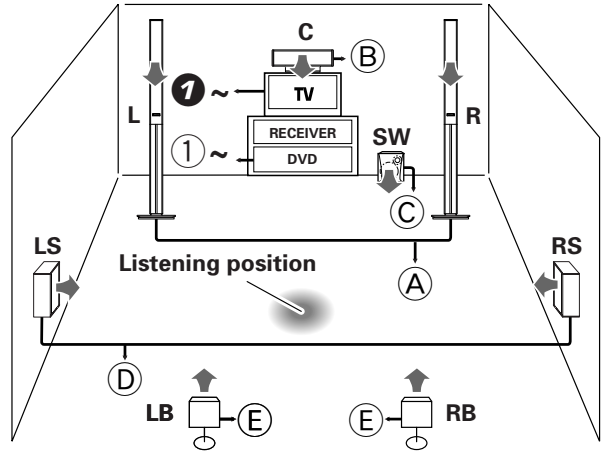

Connection of DVD player:

①	Composite video connection
②	Analog audio connection
③	Digital audio connection (Coaxial code)

Connection of TV monitor:

①	Composite video connection
---	----------------------------

STEP 2 Set up the speakers.

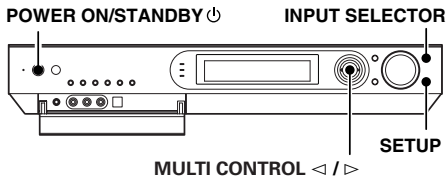

For details, see "Speaker settings". --18 ~ --21

1 Connect the power cord to the AC wall outlet and press .

2 Press , press to select "SP SETUP" and press .

If you connect KENWOOD speaker system KS-2100HT, KS-708HT or KS-908HT:

Press to select the model of the connected speaker system and press .

"HTB 1": Speaker system KS-2100HT.

"HTB 2": Speaker system KS-708HT.

"HTB 3": Speaker system KS-908HT.

Model availability may differ depending on the country and sales area.

When "TEST TONE" is displayed, press to select "EXIT" and then press .

- When the speaker setting is set to "HTB 1", "HTB 2" or "HTB 3", the DOLBY PRO LOGIC IIX, DTS-ES and DOLBY DIGITAL EX listen modes cannot be selected.
- More detailed settings such as the volume level of each speaker and distance to each speaker are also available. --19 ~ --21

If you use another speaker system want a setup according to it:

Press to select "CUSTOM" and press to select each of the speaker setup items.

Press to select the speaker setup item and press .

SUBW	<p>SUBW ON: A subwoofer is connected.</p> <p>SUBW OFF: No speaker is connected.</p>
FRNT	<p>Speaker size:</p> <p>LRG: Relatively large-size speakers.</p> <p>NML: Normal-size speakers.</p>
CNTR, SURR, BS	<p>Speaker size:</p> <p>LRG: Relatively large-size speakers.</p> <p>NML: Normal-size speakers.</p> <p>OFF: No speaker is connected.</p>

Press until "TEST TONE" is displayed, press to select "EXIT" and then press .

- When the speaker setting is set to "BS OFF", the DOLBY PRO LOGIC IIX, DTS-ES and DOLBY DIGITAL EX listen modes cannot be selected.
- More detailed settings such as the volume level of each speaker and distance to each speaker are also available. --19 ~ --21

STEP 3 Play a disc on the DVD player.

1 Press to select "DVD".

2 Start playback of the DVD player.

For the operation, also refer to the instruction manual for your DVD player.

- You can select various listen modes to enjoy surround playback of various kinds of video software. --30

Preparing for playback

Speaker settings

To enable you to obtain optimum enjoyment from the receiver's listening modes, make sure to complete the speaker settings (Subwoofer, Front, Center, Surround and Surround Back speakers) as described below.

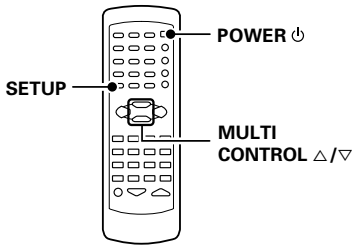
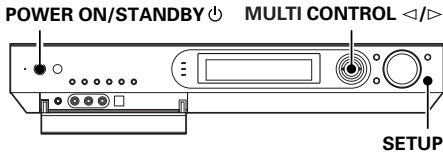

1 Turn on the power to this receiver by pressing the **POWER ON/STANDBY** button (or **POWER** key).

2 If you want to use the remote control unit, press the **RECEIVER** key on the remote to set it to the receiver control mode.

3 Initiate the setup mode.

- 1 Press the **SETUP** key.
- 2 Use the **MULTI CONTROL** button (or the **MULTI CONTROL** Δ/∇ keys) for the following displays.

- 1 "SP SETUP"
- 2 "TEST TONE"
- 3 "DISTANCE"
- 4 "LFE LEVEL"
- 5 "EXIT"

- While the main setup display is appeared, the setup mode can be canceled by selecting "EXIT" and then pressing the **SETUP** key.

The flow of the SETUP is as follows;

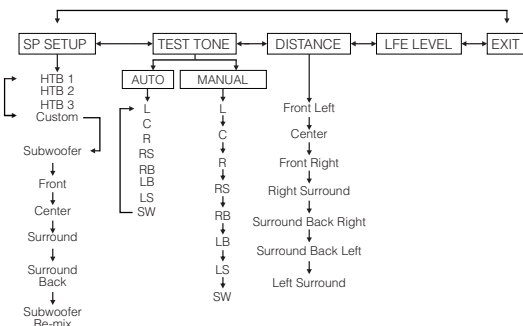

4 Select a speaker system.

- 1 Select "SP SETUP" and press the **SETUP** key again so that the speaker system indication "SP SYSTEM" scrolls across the display.

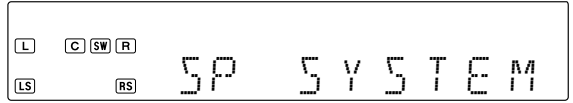

2 Use the **MULTI CONTROL** button (or the **MULTI CONTROL** Δ/∇ keys) to select the speaker system setting.

- 1 "HTB 1": Select "HTB 1" if you use speaker system KS-2100HT.
 - 2 "HTB 2": Select "HTB 2" if you use speaker system KS-708HT.
 - 3 "HTB 3": Select "HTB 3" if you use speaker system KS-908HT.
 - 4 "CUSTOM": Select to set up the speakers according to the speaker system in use. (Speaker setup is required every time after the speaker system is changed.)
- When the setting "HTB 1", "HTB 2" or "HTB 3" is selected, the procedure skips to step 5.
 - When you use a KENWOOD speaker system and select "HTB 1", "HTB 2" or "HTB 3" set the speaker setup, the audio will be corrected automatically according to the speaker characteristics.
 - When the speaker setting is set to "HTB 1", "HTB 2", "HTB 3" or "BS OFF" the DOLBY PRO LOGIC IIx, DTS-ES and DOLBY DIGITAL EX listen modes cannot be selected.

3 For general speaker setting, use the **MULTI CONTROL** button (or the **MULTI CONTROL** Δ/∇ keys) to select "CUSTOM", and press the **SETUP** key again.

- The subwoofer setting indication "SUBW" appears.

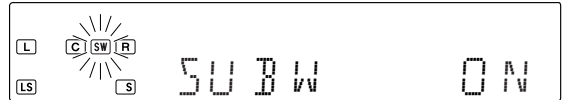

4 Use the **MULTI CONTROL** button (or the **MULTI CONTROL** Δ/∇ keys) to select the appropriate subwoofer setting.

- 1 "SUBW ON":
When a subwoofer is connected.
- 2 "SUBW OFF":
When no subwoofer is connected.

- The initial setting is "SUBW ON".
- When "SUBW OFF" is selected and the selection is established by pressing **SETUP** key in step 5 below, the front speakers are set automatically to "FRNT LRG" and the procedure jumps to step 5.

5 Press the **SETUP** key to accept the setting.

- The front speakers setting indication "FRNT" appears.

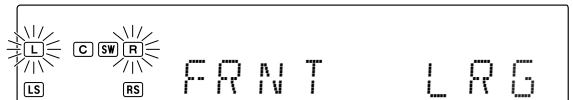

Continued to next page

6 Use the **MULTI CONTROL** button (or the **MULTI CONTROL** Δ/∇ keys) to select the appropriate front speakers setting.

- ① **"FRNT LRG"**: Large front speakers are connected to the receiver.
- ② **"FRNT NML"**: Average size front speakers are connected to the receiver.
- When the subwoofer setting is **"SUBW ON"**, front speakers setting is **"FRNT LRG"** and a stereo source is played, the low frequencies may be reproduced through the front speakers and no audio output from the subwoofer in certain listen modes. In this case, set the subwoofer re-mix setting in step 12 to **"REMIX ON"** to output the low frequencies from the subwoofer.

7 Press the **SETUP** key to accept the setting.

- The center speaker setting indication **"CNTR"** appears.

8 Use the **MULTI CONTROL** button (or the **MULTI CONTROL** Δ/∇ keys) to select the appropriate center speaker setting.

If you selected **"FRNT LRG"** as the front speakers setting:

- ① **"CNTR LRG"**: A large center speaker is connected to the receiver.
- ② **"CNTR NML"**: An average size center speaker is connected to the receiver.
- ③ **"CNTR OFF"** :
When no center speaker is connected.

If you selected **"FRNT NML"** as the front speakers setting:

- ① **"CNTR NML"**: An average size center speaker is connected to the receiver.
- ② **"CNTR OFF"**: When no center speaker is connected.

9 Press the **SETUP** key to accept the setting.

- The surround speaker setting indication **"SURR"** appears.

10 Use the **MULTI CONTROL** button (or the **MULTI CONTROL** Δ/∇ keys) to select the appropriate surround speaker setting.

If you have selected **"CNTR LRG"** as the center speaker setting:

- ① **"SURR LRG"**:
Large surround speakers are connected to the receiver.
- ② **"SURR NML"**:
Average size surround speakers are connected to the receiver.
- ③ **"SURR OFF"** :
When no surround speakers are connected.

If you have selected other than **"CNTR LRG"** as the center speaker setting:

- ① **"SURR NML"**:
Average size surround speakers are connected to the receiver.
- ② **"SURR OFF"**:
When no surround speakers are connected.

- When **"SURR OFF"** is selected and the selection is established by pressing **SETUP** in step 11 below, the procedure jumps to step 14. However, if the subwoofer setting is **"SUBW OFF"**, you can complete the speaker setup and proceed to the speaker volume level adjustment in step 5.

11 Press the **SETUP** key to accept the setting.

- The surround back speaker setting indication **"BS"** appears.

12 Use the **MULTI CONTROL** button (or the **MULTI CONTROL** Δ/∇ keys) to select appropriate surround back speaker setting.

If you selected **"SURR LRG"** as the surround speaker setting :

- ① **"BS LRG"**:
Large surround back speaker is connected to the receiver.
- ② **"BS NML"**:
Average size surround back speaker is connected to the receiver.
- ③ **"BS OFF"**:
When no surround speakers are connected.

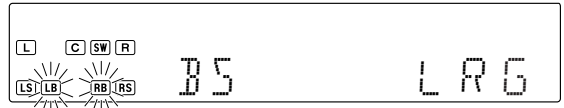

If you selected **"SURR NML"** as the surround speaker setting :

- ① **"BS NML"** :
Average size surround back speaker is connected to the receiver.
- ② **"BS OFF"** :
When no surround speakers are connected.

13 Press the **SETUP** key to accept the setting.

- The subwoofer re-mix setting indication **"REMIX"** appears.

14 Use the **MULTI CONTROL** button (or the **MULTI CONTROL** Δ/∇ keys) to select the appropriate subwoofer re-mix setting.

If **"REMIX ON"** is selected as the subwoofer re-mix setting, the low frequencies are enhanced by adding the low frequencies of other channels to the subwoofer channel or adding the low frequencies of the subwoofer to other channels depending on the speaker setup.

- ① **"REMIX ON"**: Subwoofer re-mix setting mode to the receiver is ON.
- ② **"REMIX OFF"**: Subwoofer re-mix setting mode to the receiver is OFF.
- If subwoofer is turned **"SUBW OFF"**, subwoofer re-mix setting is not visible.

15 Press the **SETUP** key to accept the setting.

5 Adjust the speaker volume level.

From your usual listening position, adjust the volume levels. The volume levels from each speaker should be the same.

- In steps 5, indications appear only for the selected channels of the speakers that require adjusting.

1 Press the **SETUP** to begin **TEST TONE**.

2 Use the **MULTI CONTROL** button (or the **MULTI CONTROL** Δ/∇ keys) to select "**AUTO**" or "**MANUAL**".

- ① "**AUTO**": Select this setting to adjust the speaker volume levels using the test tone. The test tone will be output from every speaker channel in automatic sequence.
- ② "**MANUAL**": Select to select the speaker channel to output the test tone using **SETUP** key.

Press the **SETUP** key again select either "**AUTO**" or "**MANUAL**".

Use the **MULTI CONTROL** button (or the **MULTI CONTROL** Δ/∇ keys) to adjust the volume level of the test tone output from the speaker channel to be adjusted.

For "**AUTO**" selection, the first test tone is heard from the front left speaker for 2 seconds. The next test tone is heard from the speakers in the following sequence for 2 seconds each.

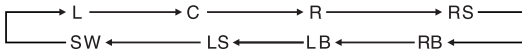

The channel indication blinks while the test tone is being output.



- If you change the volume level settings for the speakers while listening to music, the settings referred to on this page are also changed. → 32
- The speaker setting values will return to the default values when the speaker setting is set to OFF.

For "**MANUAL**" selection, press the **SETUP** key each time to select the speaker channel, and use the **MULTI CONTROL** button (or the **MULTI CONTROL** Δ/∇ keys) to adjust the volume level.

3 Press the **SETUP** key to accept the setting.

- The test tone is turned off. This model enters the mode for inputting the distance to the speakers.

6 Input the distance to the speakers.

This setting allows the signals output from different speakers to reach the listening position simultaneously.

- In steps 6, indications appear only for the selected channels of the speakers that require adjusting.

Measure the distance from the listening position to each of the speakers.

jot down the distance to each of the speakers.

Distance to Front speaker (L)	: ____ feet (meters)
Distance to Center speaker (C)	: ____ feet (meters)
Distance to Front speaker (R)	: ____ feet (meters)
Distance to Surround speaker (RS)	: ____ feet (meters)
Distance to Surround back speaker (RB)	: ____ feet (meters)
Distance to Surround back speaker (LB)	: ____ feet (meters)
Distance to Surround speaker (LS)	: ____ feet (meters)

1 Use the **MULTI CONTROL** button (or the **MULTI CONTROL** Δ/∇ keys) to select "**DISTANCE**" on setup displays, and press the **SETUP** key.

2 Use the **MULTI CONTROL** button (or the **MULTI CONTROL** Δ/∇ keys) to adjust the distance to the front speakers.

The speaker indicator to be adjusted blinks.

- The allowable setting range is 1 to 30 feet (0.3 to 9.0 m), adjustable in 1 foot (0.3 m) increments.

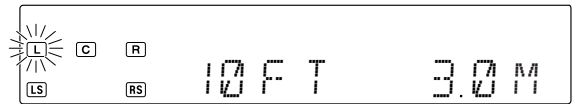

Indication in feet

Indication in meters

3 Press the **SETUP** key to accept the setting.

4 Repeat steps 2 and 3 to input the distance for each of the speakers.

7 Adjust the LFE LEVEL (Low Frequency Effects level)

Adjust the level of the low-frequency fields effect (LFE) signal, which is the signal used exclusively for giving the field effect of bass tone, in the Dolby Digital or DTS signal.

- 1 Use the **MULTI CONTROL** button (or the **MULTI CONTROL** Δ/∇ keys) to select "LFE LEVEL" on setup displays, and press the **SETUP** key.
- 2 Use the **MULTI CONTROL** button (or the **MULTI CONTROL** Δ/∇ keys) to adjust the LFE LEVEL.

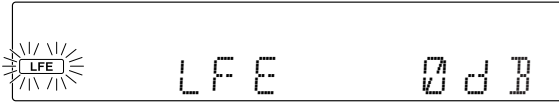

- The LFE LEVEL is adjusted from 0dB to -10dB in 1dB step decrements.

- 3 Press the **SETUP** key to accept the setting.
- 4 Setup is complete when the **EXIT** indication appears.

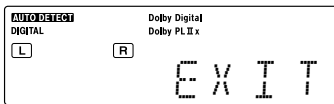

- 5 Press the **SETUP** key to exit the **SETUP** mode.

Input level adjustment (analog sources only)

If the input level of an analog source signal is too high, the "CLIP" indicator will blink to indicate the source signal. Adjust the input level.

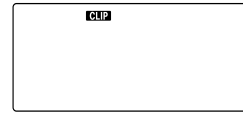

- 1 Press the **RECEIVER** key on the remote control unit to set it to the receiver control mode.
- 2 Press the **SOUND** key repeatedly until the "INPUT" indication appears.
- 3 Use the **MULTI CONTROL** button (or the **MULTI CONTROL** Δ/∇ keys) to adjust the input level.

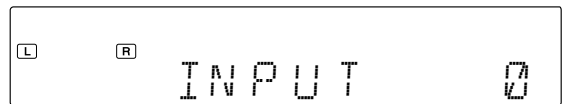

- The adjustment mode is displayed for approximately 20 seconds.
- The input level may be adjusted to any one of three settings: 0dB, -3dB, and -6dB. (The initial setting is 0dB.)
- You can store a separate input level for each input selector.

Normal playback

Some preparatory steps are needed before starting playback.

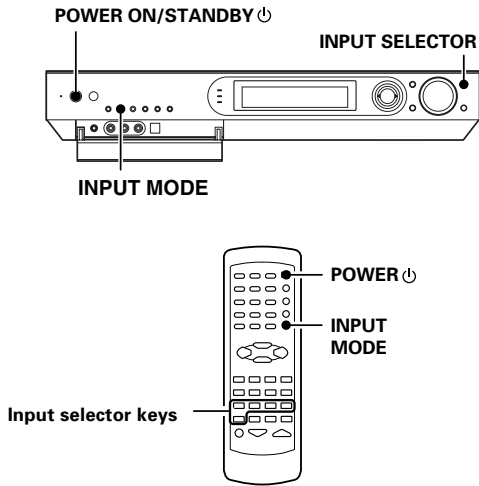

Turning on the receiver

- 1 Turn on the power to the related components.
- 2 Turn on the power to this receiver by pressing the POWER ON/STANDBY button (or the POWER button).

Selecting the input mode

If you have selected a component connected to the COAXIAL DVD, OPT. VIDEO or DIGITAL IN (OPTICAL) jacks, make sure that the input mode setting is correct for the type of audio signal to be used. → 8

Listening to a source component

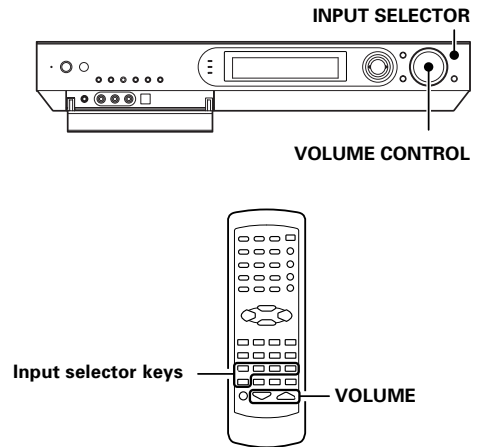

- 1 Press the INPUT SELECTOR key (or the Input selector keys/DVD, VIDEO, AUX, F.AUX, TUNER) to select the source you want to listen to.

- 1 Tuner (FM/AM broadcast reception)
- 2 "VIDEO"
- 3 "DVD"
- 4 "AUX"
- 5 "FRONT AUX"

- 2 Start playback from the selected source.

- 3 Use the VOLUME CONTROL knob (or the VOLUME +/- keys) to adjust the volume.

Adjusting the sound

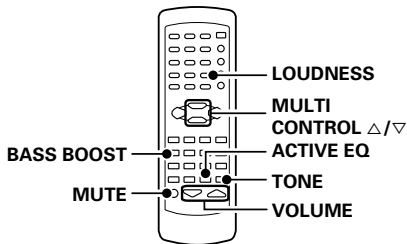
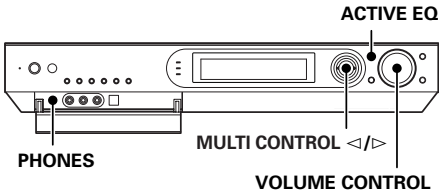

Adjusting the TONE (PCM stereo and analog stereo mode only)

- ❶ Press the **RECEIVER** key on the remote control unit to set it to the receiver control mode.
- ❷ Press the **TONE** key to select the TONE mode.
- ❸ Use the **MULTI CONTROL** button (or the **MULTI CONTROL** Δ/∇ keys) to select "TONE ON" or "TONE OFF"

Lights up

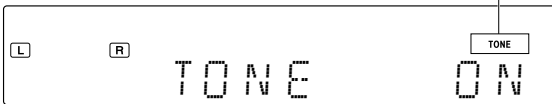

- ❹ When in "TONE ON" selection, press the **TONE** key for the following displays.

❶ "BASS" :

Select this to adjust the low frequency range.

❷ "TREBLE" :

Select this to adjust the high frequency range.

- ❺ Use the **MULTI CONTROL** button (or the **MULTI CONTROL** Δ/∇ keys) to adjust the sound quality.

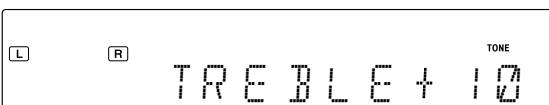

- ❻ Repeat steps ❹ and ❺ as required.

- The bass and treble levels are adjustable from -10 to +10 in 2 step increments.
- The adjustment item is displayed for approximately 20 seconds.

- ❼ Press the **TONE** key again to return to the input indication.

- The **TONE** key is defeated during tone adjustment in the SOUND mode ($[-32]$, $[-33]$) or when the listen mode is switched to a mode other than the stereo mode.

One-touch low frequency emphasis (Bass Boost)

(PCM stereo and analog stereo mode only)

You can adjust the sound quality when this model is in the PCM stereo and analog stereo modes.

- ❶ Press the **RECEIVER** key on the remote control unit to set it to the receiver control mode.
- ❷ Press the **BASS BOOST** key.
 - Press the key once to select the maximum (+10) low frequency emphasis setting.
 - TONE mode will automatically be turned ON.
 - The **BASS BOOST** key is defeated during tone adjustment in the SOUND mode ($[-32]$, $[-33]$) or when the listen mode is switched to a mode other than the stereo mode.

Switching back to the previous setting

Press the **BASS BOOST** key.

Adjusting the LOUDNESS mode

(PCM stereo and analog stereo mode only)

You can adjust the Loudness function which controls the low volume settings to maintain the music's richness.

- ❶ Press the **RECEIVER** key on the remote control unit to set it to the receiver control mode.
- ❷ Press the **LOUDNESS** key to turn the LOUDNESS setting ON.

To cancel

Press the **LOUDNESS** key again.

ACTIVE EQ mode

You can enjoy a more impressive sound effect when ACTIVE EQ is turned ON.

Press the **ACTIVE EQ** key for the following selections:

- ❶ "EQ MUSIC" : (The "ACTIVE EQ" indicator lights up)
Effective when listening to music.
- ❷ "EQ CINEMA" : (The "ACTIVE EQ" indicator lights up)
Effective when watching a movie.
- ❸ "EQ GAME" : (The "ACTIVE EQ" indicator lights up)
Effective when playing a game.
- ❹ "EQ OFF" : (The "ACTIVE EQ" indicator goes off)
The ACTIVE EQ function is turned OFF.

- ACTIVE EQ function will not be available when REC MODE, AUTO TUNING or PRESET MEMORY is ON and during 96kHz LPCM playback.

Muting the sound

The **MUTE** key lets you mute the sound of the speakers or headphones.

Press the MUTE key.

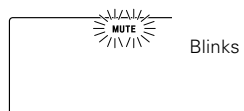

To cancel

Press the MUTE key again so that the "MUTE" indicator goes off.

- MUTE ON can also be deactivated by turning the **VOLUME CONTROL** knob or pressing the **VOLUME +/-** keys.

Listening with headphones

- 1 **Connect headphones to the PHONES jack.**



- 2 **Use the VOLUME CONTROL knob (or the VOLUME +/- keys) to adjust the volume.**

Recording

Analog sources

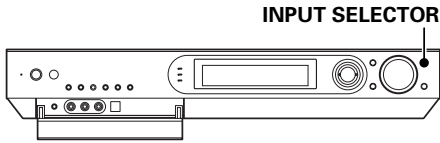

- ❶ Use the **INPUT SELECTOR** key (or the input selector key) to select the source (other than "VIDEO") you want to record.
- ❷ Put the component connected to the **VIDEO** jacks to the record-pause mode.
- ❸ Start playback, then start recording.
 - Recording may not be normal for some video software. This is due to the copy guard condition. -35

Digital sources

Switch on the **REC MODE** to record a digital input source. Usually use the **AUTO REC MODE** to record audio input sources. When the digital mode changes during recording in the **AUTO REC MODE**, the audio signal may be interrupted momentarily.

Recording music in AUTO REC or MANUAL REC mode

When a multi-channel source such as the Dolby Digital or DTS input signal is recorded in **AUTO REC** or **MANUAL REC** mode, the signal in the current multi channel signal can be recorded down-mixed to 2-channel.

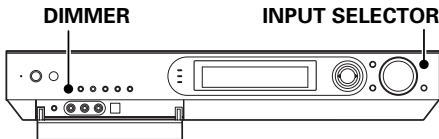

- ❶ Use the **INPUT SELECTOR** key (or the Input Selector keys) to select the source (DVD, VIDEO, FRONT AUX) you want to record.
- ❷ Put the component connected to the **VIDEO** jacks to the record-pause mode.
- ❸ Press and hold the **DIMMER** key for more than 2 seconds to select the **AUTO REC** or **MANUAL REC** mode.

- ➔ ❶ REC mode off
- ❷ "A-REC": AUTO REC mode
- ❸ "M-REC": MANUAL REC mode

Multi-channel digital signals (DTS or Dolby Digital) are down-mixed to 2-channel before being output from the analog recording (REC OUT) jacks.

When the **MANUAL REC** mode is selected, the input signal is down-mixed to 2-channel before being output, but no signal is output if the source is switched to another digital signal. When the **AUTO REC** mode is selected, the type of digital signal is automatically detected and down-mixed to 2-channel even when the digital signal is switched.

For **AUTO REC** mode :

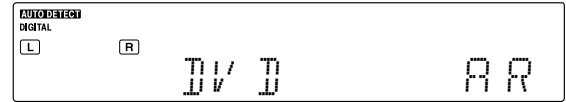

The display switches automatically.

For **MANUAL REC** mode :

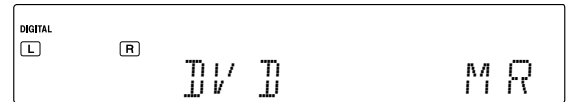
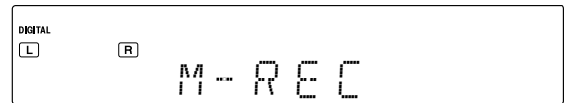

The display switches automatically.

- ❹ Start playback, then start recording.

- If the audio reproduction stops in the middle due to change in the input signals, etc., press the **DIMMER** key.

Listening to radio broadcasts

The receiver can store up to 40 stations in the memory and recall them by one-touch operation.

Tuning radio stations

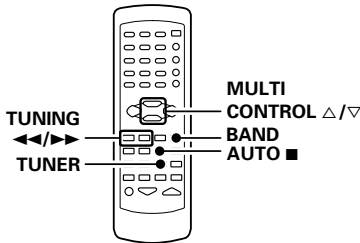
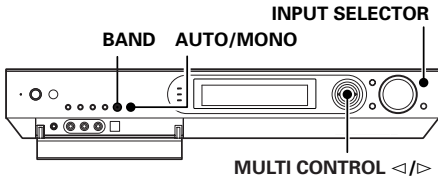

1 Use the **INPUT SELECTOR** key (or the **TUNER** key) to select the tuner.

2 Use the **BAND** key to select the desired broadcast band.

Each press switches the band.

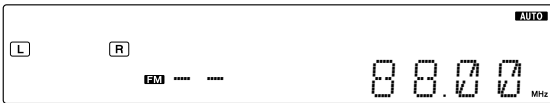

3 Use the **AUTO/MONO** key (or the **AUTO** ■) to select the desired tuning method.

Each press switches the tuning method to either auto or manual tuning.

① **Auto tuning:**

The "AUTO" indicator lights up

② **Manual tuning:**

The "AUTO" indicator goes off

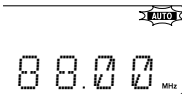

"AUTO" indicator lights up in the display.

- Normally, set to "AUTO" (auto tuning). If the radio waves are weak and there is a lot of interference, switch to manual tuning. (With manual tuning, stereo broadcasts will be received in monaural.)

4 Use the **MULTI CONTROL** button (or the **MULTI CONTROL** Δ/∇ keys, **TUNING** \leftarrow/\rightarrow keys) to select the station.

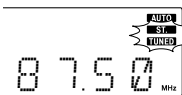

"TUNED" indicator is displayed when a station is received. "ST." indicator lights when a broadcast is being received in stereo.

Auto tuning :

The next station is tuned automatically.

Manual tuning :

Use the **MULTI CONTROL** button (or the **MULTI CONTROL** Δ/∇ keys) to select the desired station.

Presetting radio stations

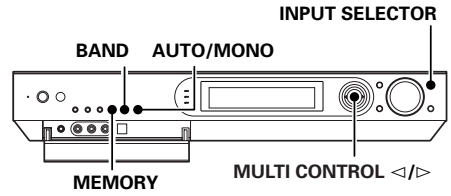

1 Use the **INPUT SELECTOR** key (or the **TUNER** key) to select the tuner.

2 Press the **MEMORY** while receiving the station.

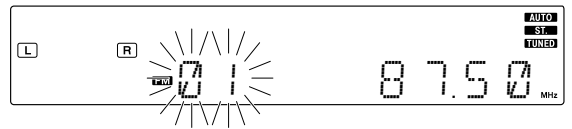

Proceed to step **3** within 20 seconds. (If more than 20 seconds elapse, press the **MEMORY** again).

3 Use the **MULTI CONTROL** button (or the **MULTI CONTROL** Δ/∇ keys) to select one of the station presets (1 – 40).

4 Press the **MEMORY** again to confirm the setting.

- Repeat steps **1**, **2**, **3** and **4** to store as many stations as necessary.
- If you store a station at a previously used preset, the old station will be replaced by the new one.

Receiving preset stations

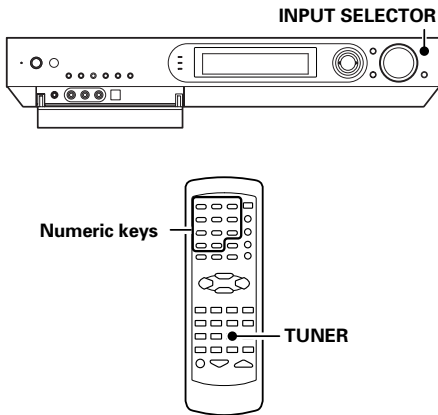

- 1** Use the **INPUT SELECTOR** key (or the **TUNER** key) to select tune as the source.
- 2** Enter the number of the preset station you want to receive (up to "40").

Press the numeric keys in the following order:

- For "15", press **+10**, **5**
- For "20", press **+10**, **+10**, **0**

- If you make a mistake entering a two digit number, press the +10 key repeatedly to return to the original display and start again.

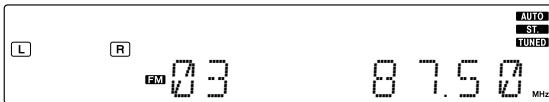

Receiving preset stations in order (P.CALL)

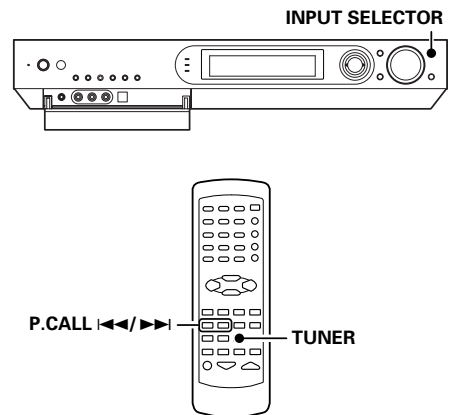

- 1** Use the **INPUT SELECTOR** key (or the **TUNER** key) to select tune as the source.
- 2** Use the **P.CALL** **◀◀/▶▶** key to select the desired station.

- Each time you press the key, another preset station is received in order.

Pressing the **P.CALL ▶▶** does the following:

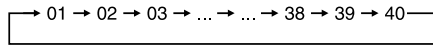

Pressing the **P.CALL ◀◀** does the following:

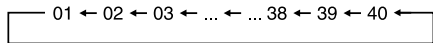

Holding down the **P.CALL ▶▶** or **◀◀** key, lets you skip through the presets, receiving each preset station at 0.5 second intervals.

Ambience effects

This receiver is equipped with listening modes that allow you to enjoy an enhanced sonic ambience with a variety of video sources.

In order to obtain the optimum effect from the surround modes, make sure to input the proper speaker settings beforehand. → 18

Surround modes

L R (Front speakers)

C (Center speaker)

SW (Subwoofer)

LS RS (Surround speakers)

LB RB (Surround back speakers)

Dolby Digital EX

Dolby Digital EX is an extension of Dolby Digital technology, Dolby Digital EX creates six full-bandwidth output channels from 6.1-channel sources. This is done using a matrix decoder that derives three surround channels from the two in the original recording.

This is achieved by using three different surround signals, Left Surround, Right Surround, and Back Surround, each driving its own array of speakers. Think of it as adding a center channel for the rear speakers, which give more diffuse and natural surround effect, even if you wanted the ability to completely encircle the audience with sound, positioning sound effects exactly where they would be heard in real life.

Note

For best results, Dolby Digital EX should be used with movie soundtracks recorded with Dolby Digital Surround EX which contain a digital flag that will automatically activate this feature. However, for titles released prior to late 2001, this feature has to be activated manually.

This model lets you enjoy Dolby Digital (and Dolby Surround) program sources, even if you connect only the Front Speakers. However, in order to enjoy the benefit of true 6.1 channel Dolby Digital Surround EX sound, KENWOOD recommends that you connect a full set of speakers.

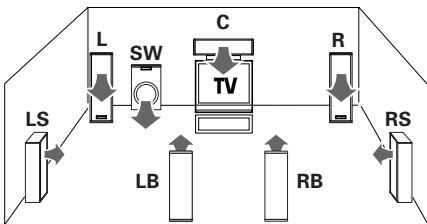

Dolby PRO LOGIC IIX/Dolby PRO LOGIC II

Dolby Pro Logic IIX was designed specifically to provide a new sense of spatiality, directionality and articulation of sounds from Dolby Surround encoded sources.

This is achieved with an intelligent, built-in feedback logic design, a matrix surround decoding and the decoding of stereo, full bandwidth surround outputs. The PRO LOGIC IIX modes programmed into this receiver are "MOVIE", "MUSIC" and "GAME". The "MOVIE" mode of the PRO LOGIC IIX has preset characteristics to produce a calibrated, high-level surround sound playback while the "MUSIC" mode has user-adjustable characteristics to offer the three optional controls, like "Dimension", "Center Width" and "Panorama" modes to allow optimization of the soundfields as desired. The "Dimension" control allows the user to gradually adjust the soundfield either towards the front or towards the rear; the "Center Width" control allows various adjustment of the left-center-right speakers' balance; the "Panorama" mode extends the front stereo image to include the surround speakers for an exciting "wraparound" effect with side wall imaging. The "GAME" mode is designed for playing video games and enhances the powerful feeling of sound.

Dolby PRO LOGIC IIX

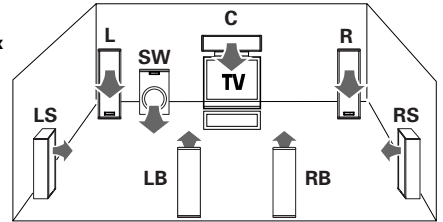

Dolby PRO LOGIC II

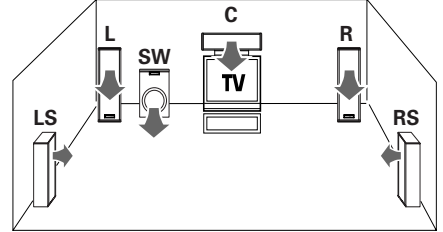

Dolby Digital

Dolby Digital surround format lets you enjoy up to 5.1 channels of digital surround sound from Dolby Digital program sources (such as Laserdisc or DVD software marked ). Compared with previous Dolby surround, Dolby Digital provides even better sound quality, greater spatial accuracy, and improved dynamic range.

This model lets you enjoy Dolby Digital (and Dolby Surround) program sources, even if you connect only the Front Speakers. However, in order to enjoy the benefit of true 5.1 channel Dolby Digital surround sound, KENWOOD recommends that you connect a full set of speakers.

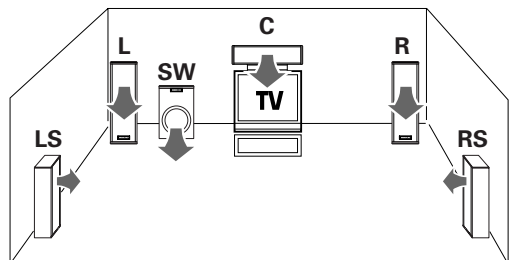

DTS-ES

The DTS-ES (Digital Theater System-Extended Surround) represents 6.1-channel Discrete Surround format, expanding upon 5.1 surround. DTS-ES format is a 6.1 channel sound system for movie theaters that includes an additional surround center channel matrixed within surround left and surround right. It's compatible on predecessor DTS 5.1 system. The extra channel allows more accurate placement and steering of sound across the rear soundstage. The DTS-ES receiver will be required, to experience a discrete 6.1-channel mix. The DTS-ES decoders used in home cinema systems have decoding options for utilizing the extra channel, in addition to processing existing 5.1 channel surround sound :

DTS-ES Discrete 6.1 and DTS-ES Matrix 6.1 add the surround back channel audio to the DTS 5.1-channel format to improve the acoustic positioning and makes acoustic image movement more natural with the 6.1-channel reproduction.

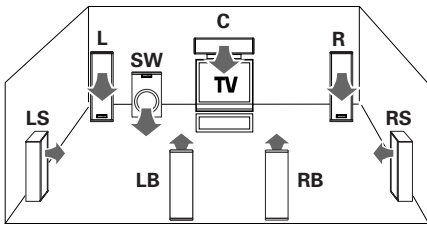

NEO:6

NEO:6 is a new technology which decodes 2-channel signals into 6-channel signals using high-accuracy digital matrix technology. For the best results, DTS-ES should be used with movie sound tracks recorded with DTS-ES format which contain a digital flag that will automatically activate this feature. However, for some titles, this feature has to be activated manually. According to the signals to be played back, DTS NEO:6 uses either the NEO:CINEMA mode optimized for movie playback or the NEO:MUSIC mode optimized for music playback.

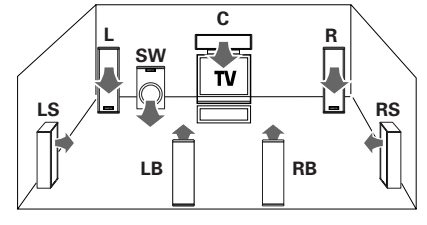

DTS

The DTS employs a larger amount of data than Dolby Digital to play surround sound with higher quality. The DTS can be used with DVD and LaserDisc software carrying the  mark. Although the number of channels is 5.1 and identical to Dolby Digital, the DTS format features lower audio compression rate in digital recording, which enables audio with more profoundness and higher S/N. The wider dynamic range and better channel separation also contribute to make the surround sound more precise and larger in scale.

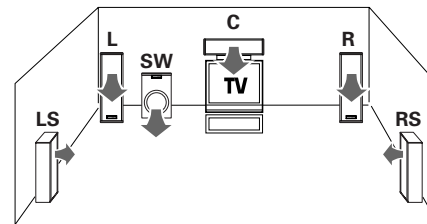

DSP mode

The DSP mode lets you add the atmosphere of a live concert or hall to almost any type of program source. These modes are particularly effective when used with stereo program sources, like CD, television, and FM radio. You might enjoy trying the ARENA, JAZZ CLUB, THEATER, STADIUM or DISCO mode the next time you watch a concert or sporting event!

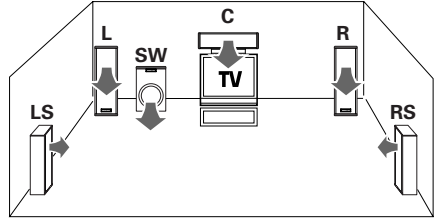

What's DSP?

DSP stands for Digital Signal Processor. The way a sound is heard in an actual environment depends on a variety of different factors. One of the most important is reverberation (the act of decaying elements of sound echoing in various places). The DSP modes produce the feeling of presence by using the DSP to create reverberation, without spoiling the sound quality of the original signal.

Manufactured under license from Dolby Laboratories. "Dolby", "Pro Logic", "Surround EX" and the double-D symbol are trademarks of Dolby Laboratories.

"DTS", "DTS-ES Extended Surround" and "Neo:6" are trademarks of Digital Theater Systems, Inc. 

LFE = Low Frequency Effects. This channel delivers separate non-directional bass signals to the subwoofer for more dynamic deep bass sound effects. When there is a LFE channel input in the DOLBY DIGITAL or DTS format, the 'LFE' indicator lights on the display of the receiver.

Surround play

The desired listen mode can be selected according to the input signal.

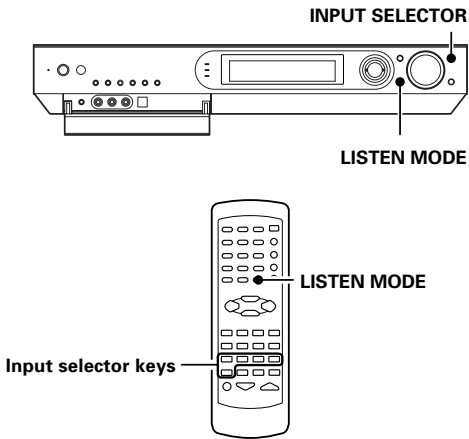

Preparations

- Turn ON related components.
- Complete **"Preparing for playback" (speaker settings)**. → [18]
- Use the **INPUT SELECTOR** key (or Input Selector keys) to select the component you wish to play back with surround sound.
- Use the **INPUT MODE** key to select the input mode (analog or digital) for the source you wish to playback. → [8]
- Noise will be produced when a DTS source is played by selecting the analog input.

1 Start playing the video software.

2 Press the LISTEN MODE key to select the listening mode.

The listening mode settings are stored separately for each input selector.

If the input mode is set to full auto ("AUTO DETECT" lights), this model selects the optimal listening mode automatically based on the type of input signal and the speaker settings.

Each press the LISTEN MODE key switches the setting as listed.

The listening mode settings are different depending on the type of input signal.

Listen modes available with Dolby Digital EX or Dolby Digital playback: ("Dolby D" indicator lights up)

Main example of medium:

Multi-channel digital source such as DVD.

- ① **"DOLBY D"**:
DOLBY DIGITAL surround
- ② **"DOLBY D EX"**:
DOLBY DIGITAL EX surround *
- ③ **"DOLBY D + PLIIx MOVIE"**:
DOLBY DIGITAL surround +
DOLBY PRO LOGIC IIx surround MOVIE mode *
- ④ **"DOLBY D + PLIIx MUSIC"**:
DOLBY DIGITAL surround +
DOLBY PRO LOGIC IIx surround MUSIC mode *
- ⑤ **"STEREO"**:
Normal stereo playback.

* When the speaker setting is set to **"BS OFF"**, the DOLBY DIGITAL EX and DOLBY DIGITAL + DOLBY PRO LOGIC IIx listen modes cannot be selected.

- You can also adjust the midnight mode as desired. → [33]

Listen modes available with DTS or DTS-ES (Matrix or Discrete) playback: ("DTS" indicator lights up)

Main example of medium:

Multi-channel digital source such as DVD.

- ① **"DTS"**:
DTS surround
- ② **"DTS + NEO6 CINEMA"**:
DTS surround + DTS NEO:6 surround CINEMA mode *
- ③ **"DTS-ES MATRIX 6.1"**:
DTS-ES 6.1-channel Matrix surround *
- ④ **"DTS-ES DISCRETE 6.1"**:
DTS-ES 6.1-channel Discrete surround *
- ⑤ **"STEREO"**:
Normal stereo playback.

* When the speaker setting is set to **"BS OFF"**, the DTS + NEO:6 CINEMA, DTS-ES 6.1-channel Matrix and DTS-ES 6.1-channel Discrete listen modes cannot be selected.

- You can also adjust the midnight mode as desired. → [33]

Listen modes available with analog or PCM playback:

Main example of medium:

- Digital sources including DVD linear PCM and CD.
- Analog source such as VCR or radio broadcasting.

-
- ① **"PL IIx MOVIE":**
DOLBY PRO LOGIC IIx surround MOVIE mode *1

 - ② **"PL IIx MUSIC":**
DOLBY PRO LOGIC IIx surround MUSIC mode *1 *2

 - ③ **"PL IIx GAME":**
DOLBY PRO LOGIC IIx surround GAME mode *1

 - ④ **"PL II MOVIE":**
DOLBY PRO LOGIC II surround MOVIE mode

 - ⑤ **"PL II MUSIC":**
DOLBY PRO LOGIC II surround MUSIC mode *2

 - ⑥ **"PL II GAME":**
DOLBY PRO LOGIC II surround GAME mode

 - ⑦ **"PRO LOGIC":**
DOLBY PRO LOGIC surround

 - ⑧ **"NEO6 CINEMA":**
DTS NEO:6 surround CINEMA mode

 - ⑨ **"NEO6 MUSIC":**
DTS NEO:6 surround MUSIC mode

 - ⑩ **"ARENA":**
DSP surround ARENA mode

 - ⑪ **"JAZZ CLUB":**
DSP surround JAZZ CLUB mode

 - ⑫ **"THEATER":**
DSP surround THEATER mode

 - ⑬ **"STADIUM":**
DSP surround STADIUM mode

 - ⑭ **"DISCO":**
DSP surround DISCO mode

 - ⑮ **"STEREO":**
Normal stereo playback.
-

*1 When the speaker setting is set to **"BS OFF"**, the DOLBY PRO LOGIC IIx listen modes cannot be selected.

*2 The sound field can be adjusted as desired using the PANORAMA, DIMENSION and CENTER WIDTH modes. → [32] → [33]

- The listen mode is fixed to stereo when the 96 kHz linear PCM signal is input.

3 Adjust the volume.

Note

- Certain modes may be unavailable depending on the type of input signal or speaker setting.
- If an optimum surround effect cannot be obtained or the desired mode cannot be selected, check the speaker and input mode settings. → [8] → [18]

Dolby Digital Surround EX compliant disc :

Dolby Digital Surround EX compliant disc contains identification signals. When you choose FULL AUTO during **"Input mode settings"** (→ [8]), this amplifier detects the identification signals and change the LISTEN mode to the DOLBY DIGITAL EX (Dolby Digital Surround EX mode) automatically. But sometimes we find some discs which are Dolby Digital Surround EX compliant disc but it does not contain the identification signals. If you find the notice like "Surround EX" on the label of disc or package, you can choose DOLBY DIGITAL EX, then you can enjoy Dolby Digital Surround EX sound.

Convenient functions

You can make further adjustments to the sound while listening to playback in the surround mode.

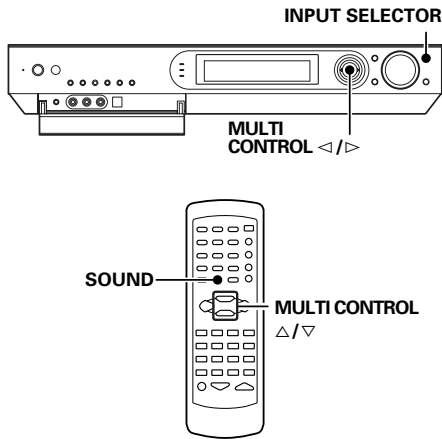

Adjusting the SOUND

- ➊ Press the **RECEIVER** key on the remote control unit to set it to the receiver control mode.
- ➋ Press the **SOUND** key until the desired item appears in the display.

Each time you press the button, the menu changes as follows:
Note that some items are not displayed depending on speaker settings and listening mode.

- ➊ **"C"**: *1
Center speaker level adjustment
- ➋ **"RS"**: *1
Right surround speaker level adjustment
- ➌ **"RB"**: *1
Surround back right speaker level adjustment
- ➍ **"LB"**: *1
Surround back left speaker level adjustment
- ➎ **"LS"**: *1
Left surround speaker level adjustment
- ➏ **"SW"**: *1
Subwoofer level adjustment
- ➐ **"INPUT"**: (Analog mode only) - [21]
Input level adjustment
- ➑ **"NIGHT"**: *2 - [33]
Midnight mode adjustment
- ➒ **"PANORAMA"**: *3
Panorama mode ON/OFF
- ➓ **"DIMENSION"**: *3
Dimension adjustment
- ➔ **"CENTER WIDTH"**: *3 - [33]
Center width adjustment

*1 The setting in the SOUND mode is temporary. It returns automatically to the original level set in "Speaker settings" when the receiver is turned OFF/ON.

*2 DOLBY DIGITAL, DTS mode only

*3 Only when the input signal is a 2-channel signal in the DOLBY PRO LOGIC IIx MUSIC or DOLBY PRO LOGIC II MUSIC mode.

- ➋ Use the **MULTI CONTROL** button (or the **MULTI CONTROL** Δ/∇ keys) to adjust the setting as desired.

• The adjustment item is displayed for approximately 20 seconds.

- ➌ Press the **SOUND** key to advance to the next setting item.

Panorama mode

(Only when the input signal is a 2-channel signal in the DOLBY PRO LOGIC IIx MUSIC or DOLBY PRO LOGIC II MUSIC mode)

When listening to music, you will be able to enjoy the "wraparound" sound effect when you adjust the panorama mode.

- ➊ Press the **RECEIVER** key on the remote control unit to set it to the receiver control mode.
- ➋ Press the **SOUND** key repeatedly until the "PANORAMA" indication appears.
- ➌ Use the **MULTI CONTROL** button (or the **MULTI CONTROL** Δ/∇ keys) to select PANORAMA mode "ON" or "OFF".



Dimension mode

(Only when the input signal is a 2-channel signal in the DOLBY PRO LOGIC IIx MUSIC or DOLBY PRO LOGIC II MUSIC mode)

When listening to music with certain recordings, you will also be able to achieve a suitable balance from all the speakers by adjusting the dimension mode.

- ➊ Press the **RECEIVER** key on the remote control unit to set it to the receiver control mode.
- ➋ Press the **SOUND** key repeatedly until the "DIMENSION" indication appears.
- ➌ Use the **MULTI CONTROL** button (or the **MULTI CONTROL** Δ/∇ keys) to adjust the soundfield towards the rear or the front.

Soundfield is adjusted towards the front.

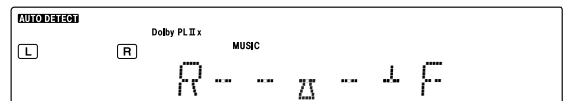

Standard setting.

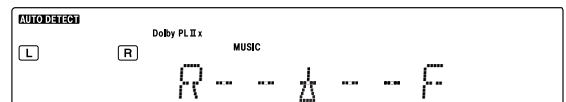

Soundfield is adjusted towards the rear.

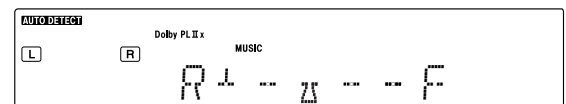

Center Width mode

(Only when the input signal is a 2-channel signal in the DOLBY PRO LOGIC IIx MUSIC or DOLBY PRO LOGIC II MUSIC mode)

Center width adjustment allows you to enjoy an enhanced sound when listening to music through center image from only center speaker, or left and right speakers or various combinations adjustments.

❶ Press the RECEIVER key on the remote control unit to set it to the receiver control mode.

❷ Press the SOUND key repeatedly until the "CENTER WIDTH" indication appears.

- When the center speaker is switched OFF, this mode will not be effective.

❸ Use the MULTI CONTROL button (or the MULTI CONTROL Δ/∇ keys) to adjust the left-center-right output.

Center image will be heard from center speaker only.

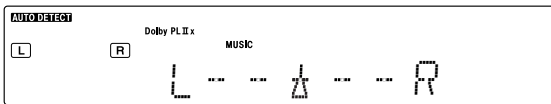

Center image will be heard from left and right speakers only.



- When in other position, center image from center speaker, left and right speakers can be heard simultaneously with various combinations.

Midnight mode

(DOLBY DIGITAL and DTS mode only)

When watching movies at night, you might not be able to raise the volume as loud as normal. Midnight mode compresses the dynamic range of previously specified parts of the DOLBY DIGITAL or DTS sound track (like scenes with sudden increases in volume) to minimize the difference in volume between the specified and non-specified parts. This makes it easy to hear all of the sound track, even when listening at low volumes.

❶ Press the RECEIVER key on the remote control unit to set it to the receiver control mode.

❷ Press the SOUND key repeatedly until the "NIGHT" indication appears.

- This can be selected only if DVD, VIDEO or FRONT AUX is selected as the source and the listen mode is set to "DOLBY DIGITAL" or "DTS".

❸ Use the MULTI CONTROL button (or the MULTI CONTROL Δ/∇ keys) to select the "NIGHT ON" or "NIGHT OFF" setting.

- ➔ ① "NIGHT ON"
- ➔ ② "NIGHT OFF"



- The adjustment item is displayed for approximately 20 seconds.
- Some DOLBY DIGITAL or DTS software may not be compatible with the Midnight mode.

Display dimmer adjustment

The dimmer function lets you select the brightness of the receiver's display. You might find this useful if you darken your room to watch movies or listen to music.

Each time you press the DIMMER key, the display's brightness changes among the three available settings.

Select the brightness level you find most pleasing.

- ➔ ① Bright
- ➔ ② Medium
- ➔ ③ Dark

Basic remote control operations for other components

DVD player operation keys

The remote control of this unit can control two groups of KENWOOD DVD players directly without using the remote control supplied with the DVD player.

Group-1 : DV-4900, DV-4070B, DV-2070, DV-203, DVF-9010, DVF-K7010, DVF-5010, DVF-R9030, DVF-R7030, DVF-3530, DV-402, DV-5900, DV5700, DVF-R9050, DVF-J6050, DV-505, DV-503, DV-502, DVF-3550, DVF-3050, DVF-R4050, DVF-R4050, DVF-605, DV-6050, DVF-R5060, DVF-3060, DVF-3060K, DV-705, DVF-R5070, DVF-3070, DVF-3080, DVF-N7080 and DVF-8100.

Group-2 : DV-4050, DV-303, DVF-R6030, DVF-K5020, DVF-5020, DVF-3020 and DVF-3030.

Depending on your KENWOOD DVD model, you need to set up your remote control as follows:

To set for Group-1 DVD players:

Press the numeric "1" key while pressing the "POWER ϕ " key (not the DVD/POWER key) on your remote control.

To set for Group-2 DVD players:

Press the numeric "2" key while pressing the "POWER ϕ " key (not the DVD/POWER key) on your remote control.

- If your DVD player is not listed in the list above, perform the set up for either Group-1 or Group-2. When the set up is successful, then your DVD player falls into that particular group.

How to operate the DVD player with the remote control

1. Pressing the DVD/POWER key for more than 2 seconds turns the DVD player on or off.
2. To carry out the functions of the DVD player, first press the DVD/POWER key, then press each key for each operation as explained in the DVD operation pages in the operating instructions. In this case, the DVD operation mode is retained for 15 seconds after pressing any of those DVD operation buttons.

(To turn the receiver operation mode within 15 seconds, press the RECEIVER key.)

DVD player operation keys

You can perform these basic operations using the keys described below when connected to KENWOOD DVD player.

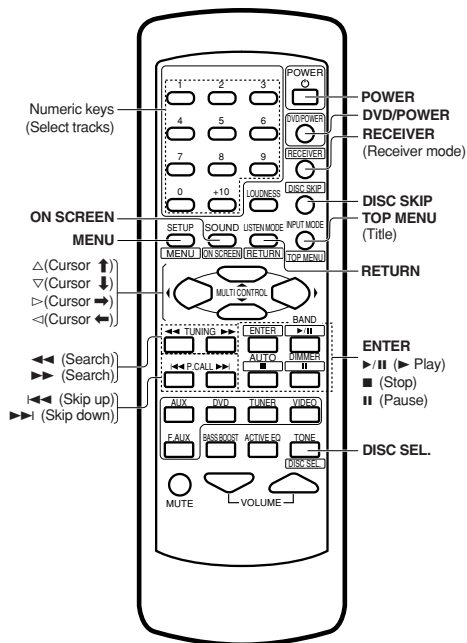

In case of difficulty













Resetting the Microcomputer

The microcomputer may malfunction (unit cannot be operated, or shows an erroneous display) if the power cord is unplugged while the power is ON, or due to some other external factor. If this happens, execute the following procedure to reset the microcomputer and return the unit to its normal operating condition.



Unplug the power cord from the wall outlet, then plug it back in while holding down the POWER ON/STANDBY  key.

- Please note that resetting the microcomputer will clear the contents of the memory and returns the unit to the state it was in when it left the factory.

Amplifier

Symptom	Remedy
No sound from the speakers.	<ul style="list-style-type: none"> ● Connect them properly referring to "Connecting the speakers"  -12 ● If muting is ON, release it.  -24 ● If headphones are connected, disconnect them.  -24 ● Press the INPUT MODE key to select to full auto mode.  -8
Sound is not output from the speaker, or their sound is very small.	<ul style="list-style-type: none"> ● Connect them properly referring to "Connecting the speakers"  -12 ● See "Speaker settings" and check if the setting for all of the speakers is correct.  -18 ● Select a surround mode.  -20 ● Adjust the speaker levels using the test tone.  -20
The standby indicator blinks and sound is not output.	<ul style="list-style-type: none"> ● Speaker cords are short-circuited. Disconnect the power cord from the AC wall outlet, switch the receiver OFF, remove the short-circuiting and turn the receiver ON again.
Audio cannot be recorded.	<ul style="list-style-type: none"> ● Connect the equipment correctly by referring to "Connecting video components, audio components" and "Digital connections".  -10  -11 ● If it is the digital audio that you attempt to record, set up the unit correctly by referring to "Recording music in AUTO REC or MANUAL REC mode".  -25
A video source cannot be recorded normally.	<ul style="list-style-type: none"> ● Copy-guarded video software cannot be recorded.
When playing a digital source signal, the sound is cut off soon after it starts.	<ul style="list-style-type: none"> ● There are many possible causes for this problem, depending on the type of player used. Switch the input mode to DIGITAL MANUAL during playback of the digital source, and restart the playback from the beginning.  -8
Dolby Digital or DTS audio software cannot be played in multi-channel audio.	<ul style="list-style-type: none"> ● Check if the digital output setting of the digital audio player is correct.

Tuner

Symptom	Remedy
Radio stations cannot be received.	<ul style="list-style-type: none"> ● Connect an antenna properly.  -15 ● Set the broadcast band properly.  -26 ● Tune the frequency of the desired station.  -26
Interference.	<ul style="list-style-type: none"> ● Install the outdoor antenna away from the road. ● Turn off the power to the appliance. ● Install the receiver farther away from the TV.
A station which was preset cannot be received by pressing the corresponding numeric key.	<ul style="list-style-type: none"> ● Preset a station with a receivable frequency.

Remote control unit

Symptom	Remedy
<p>Remote control operation is not possible.</p>	<ul style="list-style-type: none"> ● Press the input selector key and select the optimum control mode. ● Replace with new batteries. ● Point the remote control unit to the remote sensor of the receiver. - [15] ● Connect them properly referring to "Setting up the system" ● The remote control has not been set to the operation mode for the KENWOOD DVD player you wish to control. Press the DVD/POWER key for more than 2 seconds to activate the operation mode for the KENWOOD DVD player you want to control before operation. - [34]

Memory back-up function

If the power supply to the receiver is shut down for about a day or more, the following settings will be reset to the initial conditions. Please be careful.

- Power mode = OFF
- Volume level = - 66 dB
- Dimmer level = OFF (Brightest condition)
- Broadcast band = FM
- Frequency setting = 87.50 MHz
- Tuning mode = AUTO
- Listen mode setting = STEREO
- Input selector settings = TUNER
- TONE ON/OFF = OFF
- LOUDNESS ON/OFF = OFF
- BASS BOOST ON/OFF = OFF

Note to CATV system installer

This reminder is provided to call the CATV system installer's attention to Article 820-40 of the NEC that provides guidelines for proper grounding and, in particular, specifies that the cable ground shall be connected to the grounding system of the building, as close to the point of cable entry as practical.

FCC WARNING

This equipment may generate or use radio frequency energy. Changes or modifications to this equipment may cause harmful interference unless the modifications are expressly approved in the instruction manual. The user could lose the authority to operate this equipment if an unauthorized change or modification is made.

NOTE:

This equipment has been tested and found to comply with the limits for a Class B digital device, pursuant to Part 15 of the FCC Rules. These limits are designed to provide reasonable protection against harmful interference in a residential installation. This equipment may cause harmful interference to radio communications, if it is not installed and used in accordance with the instructions. However, there is no guarantee that interference will not occur in a particular installation. If this equipment does cause harmful interference to radio or television reception, which can be determined by turning the equipment off and on, the user is encouraged to try to correct the interference by one or more of the following measures:

- Reorient or relocate the receiving antenna.
- Increase the separation between the equipment and receiver.
- Connect the equipment into an outlet on a circuit different from that to which the receiver is connected.
- Consult the dealer or an experienced radio / TV technician for help.



As an ENERGY STAR® Partner, Kenwood Corporation has determined that this products meets the ENERGY STAR® guidelines for energy efficiency. This product can save energy. Saving energy reduces air pollution and lowers utility bills.

Specifications

AUDIO section

Rated power output during STEREO operation

65 watts per channel minimum RMS, both channels driven, at 8 Ω from 20 Hz to 20 kHz with no more than 0.7% total harmonic distortion. (FTC)

Effective power output during STEREO operation ... 100 W + 100 W
(1 kHz, 10% T.H.D. at 8 Ω)

Effective power output during SURROUND operation

FRONT 80 W + 80 W
(1 kHz, 0.7% T.H.D. at 8 Ω one channel driven)
100 W + 100 W
(1 kHz, 10% T.H.D. at 8 Ω one channel driven)
CENTER 80 W
(1 kHz, 0.7% T.H.D. at 8 Ω one channel driven)
100 W
(1 kHz, 10% T.H.D. at 8 Ω one channel driven)
SURROUND 80 W + 80 W
(1 kHz, 0.7% T.H.D. at 8 Ω one channel driven)
100 W + 100 W
(1 kHz, 10% T.H.D. at 8 Ω one channel driven)

Total harmonic distortion 0.05% (1 kHz, 50 W, 8 Ω)

Frequency response

LINE (DVD, VIDEO, AUX, FRONT AUX)
..... 20 Hz ~ 90 kHz, +0 dB ~ -3.0 dB

Signal to noise ratio

LINE (DVD, VIDEO, AUX, FRONT AUX) 96 dB

Input sensitivity / impedance

LINE (DVD, VIDEO, AUX, FRONT AUX) 500 mV / 40 k Ω

Output level / impedance

REC OUT 500 mV / 2.2 k Ω
PRE OUT (SURROUND BACK) 700 mV / 2.2 k Ω
PRE OUT (SUBWOOFER) 1.5 V / 2.2 k Ω

Tone control

BASS ± 10 dB (at 100 Hz)
TREBLE ± 10 dB (at 10 kHz)

Loudness control

VOLUME at -30dB level +8 dB (at 100 Hz)

DIGITAL AUDIO section

Sampling frequency 32 kHz, 44.1 kHz, 48 kHz, 96 kHz

Input level / impedance / wave length

Optical (VIDEO, FRONT AUX)
..... (-15 dBm ~ -21 dBm), 660 nm ± 30 nm
Coaxial (DVD) 0.5 Vp-p / 75 Ω

VIDEO section

Input sensitivity / impedance

Composite (DVD, VIDEO, FRONT AUX) 1 Vp-p / 75 Ω

Output level / impedance

Composite (VIDEO, MONITOR OUT) 1 Vp-p / 75 Ω

FM tuner section

Tuning frequency range 87.5 MHz ~ 108 MHz

Usable sensitivity (MONO)
..... 1.3 μ V (75 Ω) / 13.2 dBf (75 kHz dev, SINAD 30 dB)

50 dB quieting sensitivity

STEREO 28 μ V (75 Ω) / 40.2 dBf (75 kHz dev)

Total harmonic distortion (1 kHz)

MONO 0.5% (71.2 dBf input)

STEREO 0.7% (71.2 dBf input)

Signal to noise ratio (1 kHz)

MONO 75 dB (71.2 dBf input)

STEREO 68 dB (71.2 dBf input)

Selectivity (± 400 kHz) 70 dB

Stereo separation (1 kHz) 40 dB

Frequency response (30 Hz ~ 15kHz) +0.5 dB, -3.0 dB

AM tuner section

Tuning frequency range 530 kHz ~ 1,700 kHz

Usable sensitivity (30% mod, S/N 20 dB) 16 μ V / (600 μ V/m)

Signal to noise ratio (30% mod, 1mV input) 50 dB

GENERAL

Power consumption 120 W

Dimensions W: 440 mm (17-5/16")

H : 79 mm (3-1/8")

D : 357 mm (14-1/16")

Weight (Net) 7.9 kg (17.4 lb)

Notes

- 1.KENWOOD follows a policy of continuous advancements in development. For this reason specifications may be changed without notice.
- 2.The full performance may not be exhibited in an extremely cold location (under a water-freezing temperature).



KENWOOD

For your records

Record the serial number, found on the back of the unit, in the spaces designated on the warranty card, and in the space provided below. Refer to the model and serial numbers whenever you call upon your dealer for information or service on this product.

Model _____ Serial Number _____